

American Standard

Pristine E-bidet

User Manual

Attached Warranty Card

CEAS7SL1-0100510P0
CEAS7SL3-0000510P0
CEAS7SL1-0100510A0
CEAS7SL2-0000510A0
CEAS7SL1-0100510V0
CEAS7SL3-0000510V0
CEAS7SL3-0000511V0

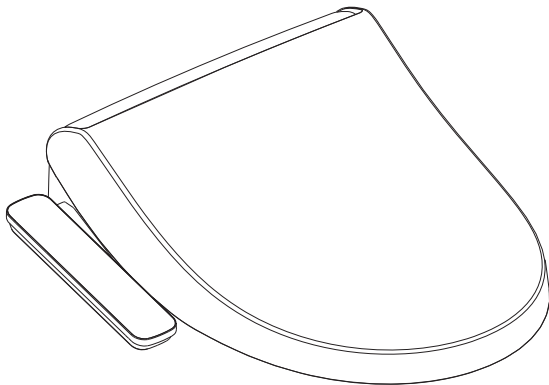

CEAS7SL1-0100510M0
CEAS7SL2-0000510M0
CEAS7SL3-0000510M0
CEAS7SS1-0100510H0
CEAS7SL2-0000510I0

- Thank you very much for selecting Pristine E-bidet from our company. Please read the manual carefully and use it correctly.
- CEAS7SL1 and CEAS7SS1 series are w/ Auto Deodorizer;
CEAS7SL2 series are w/o Auto Deodorizer;
CEAS7SL3 series are w/o Deodorizer & Dryer.
- The pictures in the manual are for reference only, please refer to actual samples.

Contents

Safeguards Cautions	1
Cautions Of Using	5
Cautions Before Installation.....	6
Components Name.....	8
Installation	10
■ Installation of E-bidet.....	10
■ Installation of E-bidet water supply hose.....	11
■ Installation of body water supply hose (body side).....	11
■ Power on confirmation.....	13
■ Test run.....	13
Operation Instruction	14
Preparation and Confirmation before Using	14
Basic Operation	16
■ Deodorization function is activated when the unit is occupied (auto deodorization).....	16
■ Shower ► Oscillating	17
■ Spray strength adjustment	17
■ Nozzle position	17
■ Bidet ► Oscillating	17
■ Massage	17
■ Warm air dryer.....	18
■ Stop (Power ON/OFF).....	18
Other Function Settings.....	19
■ One touch cleansing.....	19
■ To prevent low temperature burn.....	19
■ Resume to factory settings.....	19
■ Power Saving	20
■ Seat temp. 3 → 5 modes expansion function.....	21
■ Warm water temp.3 → 5 modes expansion function.....	21
■ Spray strength 3 → 5 modes expansion function.....	21
Information to the User	22
Cleaning And Care	24
Daily Cleaning and Care.....	24
■ Cleaning and care of seat, lid and protective cases (plastic parts)	24
■ Cleaning and Care of Nozzle	24
Cleaning after Removing Lid	25
Cleaning of Blocked Part of E-bidet.....	26
Cleaning of Nozzle Shutter	28
Cleaning Maintenance of Deodorization Filter.....	29
When Cleaning Function Decreases	30
How To Prevent Freezing And Care During Not Using For A Long Period	31
General Trouble Shooting.....	32
After-Sales Service.....	35
Anti-Bacterial	37
Specifications	38



SAFEGUARDS CAUTIONS

Please read the following "safeguards cautions" carefully before using so as to properly use the product.

Not observe the following safeguards cautions may result in serious accidents.

Please strictly observe the following content, which is closely related to your safety.

Explanation of terms and marks

WARNING	...	Improper use of the product could lead to death or personal injury.
CAUTION	...	Improper use of the product could lead to minor injury or property damage.
	...	"ATTENTION!" mark. It is used with "WARNING" and "CAUTION" above to catch your attention. Please read carefully and observe strictly.
	...	The "Prohibited" mark indicates "please do not do it!".
	...	The "observe at all times" mark indicates "please do it!".



WARNING

- Please do not stand on the lid, or use the lid to support your hand.

※ Otherwise break may be resulted in, which may lead to injury.

Please use the new water supply hose attached to product. Using the old water supply hose is prohibited, otherwise water leakage or stain may be easily occurred.

- Do not damage the power cord and make it broken, do not modify, fold, extend, curl, twine the cord by force, or excessively press the cord by placing heavy stuff on top of the cord.

※ Risk of damage of the electric cord, which may lead to electric shock or fire.

- Do not use damaged power plug and loosened plug seat. To avoid any possible dangers, if the power cord is broken, please call after-sales service department or the shop and it is necessary to perform replacement by specialized persons.

※ Risk of electric shock or fire.

- Do not use power supply other than AC 220 V.

- Do not use extensions and so on, which excess the power specifications.

※ Risk of electric shock or fire.



- If E-bidet water supply hose or water supply hose connector freezes, and no water can be ejected, cover it with a cloth soaked with warm water to make it be unfrozen or raise the room temperature to make it unfreeze naturally.

- Never turn on the power before the frozen water in E-bidet unfreezes.

※ Risk of water pipe damage or electric shock and fire.

- Never install the product at the place with high humidity or where is easy to contact with water. When using at shower, please install ventilation equipment for air to circulate.

※ Risk of electric shock or fire.

- Do not dismantle, repair or remodel the product. Only qualified service personnel should service this product.

※ Risk of electrical shock or fire, which may lead to abnormal operation and personal injury.

- Do not plug or unplug the power plug with wet hand.

※ Risk of electric shock or fire.

- Please ensure that the internal parts of both E-bidet and control panel, and the external power are not flushed with water or detergent.

※ Risk of electric shock or fire.



WARNING

	<ul style="list-style-type: none"> ● In case of any problems (abnormal noises, abnormal smell, smoking, high temperature, break) with the main unit of E-bidet, plug or power cord, please immediately unplug the power cord and contact the after-sales service. ※ Risk of electric shock or fire. ● In case of water leakage of the E-bidet or supply valve, please unplug the power cord and turn off the supply valve. ※ Otherwise electronic shock, fire or ponding could be easily occurred. ● Please regularly clean dust on the surface of the power plug. Please pull out the plug before cleaning the plug with dry cloth. ※ Otherwise too much dust may cause fire. ● Please hold the plug during unplug. ※ If you hold the cord and unplug, the plug or cord may be damaged, which could result in electric shock or fire. ● Properly plug the power plug. ※ Risk of electric shock or fire. ● In case of using the product for a long time, please set the seat temperature in "OFF" mode. ● When the following people use the product, carer should set the seat temperature and warm air dryer temperature in "OFF" mode. (Children, the elderly and patients, people who cannot adjust the temperature by themselves, people with sensitive skin, people who are taking pills like sleeping pills or others with the function of hypnosis, drunk people and people who are extremely fatigue) ※ A low temperature burn may occur when using temperatures in other modes rather than the "OFF" mode for a long time. ● In case of using the warm air dryer for a long time, please set dryer temperature at "LOW" mode. ● In case of water freezes, anti-freezing measures must be taken. ※ Risk of fire and indoor floor due to damage caused by freezing water in the toilet.
	<ul style="list-style-type: none"> ● Ensure that power supply must be grounded. ※ Risk of electric shock in case of malfunction or electric leakage. ※ In case of no ground terminals available, please contact electric installation company.
	<ul style="list-style-type: none"> ● In order to avoid the possible danger caused by reset of thermal cut-off in error, the product cannot be controlled by external switch, such as the plug seat with timer.



CAUTION

	<ul style="list-style-type: none"> ● When care and clear the plastic part of the product, do not use unsuitable detergents (toilet cleaner, apartment cleaner, decolorizer, benzene, painter thinner, souring powder, cresol, alcohol, etc.). ✘ Risk of personal injury, electric shock or fire due to broken plastic parts. ● Do not stand or sit on the seat lid. ✘ Risk of damage, which may result in personal injury. ● When removing the filter, water supply valve must be turned off. ● When installing the filter, please tighten it properly without leaving any gap. ✘ Risk of water leakage and indoor floor. ● Keep any flammable materials, including cigarette ends and ashtray, etc., away from the product. ✘ Risk of fire. ● Do not curve or damage the water supply hose. ✘ Risk of water leakage and indoor floor. ● Do not use the water supply valve to support your hand or step on the water supply valve. ✘ Risk of water leakage and indoor floor. ● Do not put your finger into the cover of the deodorization carbon block. ✘ Risk of personal injuries like injury to the finger. ● Do not lean your back against the lid. ✘ Risk of scratch and damage to the lid.
	<ul style="list-style-type: none"> ● Power plug must be unplugged when cleaning the product. ✘ Risk of electric shock. ● When the following people use the product, carer should take good care of them to prevent them from falling down. (Children, the elderly, people who cannot sit down and stand up by themselves.) ✘ Children shall not play with the product. Children are not allowed to use the product independently. ✘ Risk of personal injury or damage of the lid. ● Water supply hose must be connected to the running water and filter screen should be installed. In case of any stain or dust etc. on the filter screen, please clean the filter screen. ✘ Risk of electric shock, fire and infectious dermatitis due to inner corrosion of the product. ● Drain the water from unit and unplug the power if it is not going to be used for an extended period of time. ✘ Risk of fire and indoor floor due to damage caused by freezing water in the toilet. ✘ Risk of dermatitis due to dirty water.

CAUTIONS OF USING

■ Please strictly follow the following cautions to prevent any malfunction.

In case of thunder and lightning nearby, please disconnect the power plug from the plug seat.

※ Risk of accidents or malfunction.

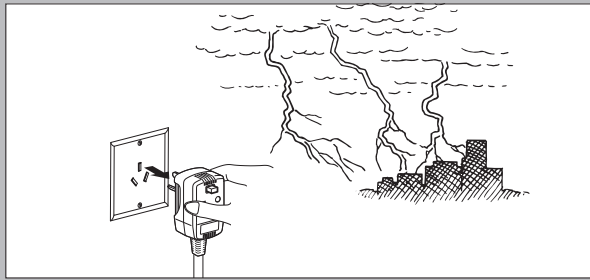

Keep heater or warmer, etc. away from the E-bidet.

※ Risk of color changer or malfunction.



Avoid direct sunlight.

※ Risk of color change of the parts made of resin.

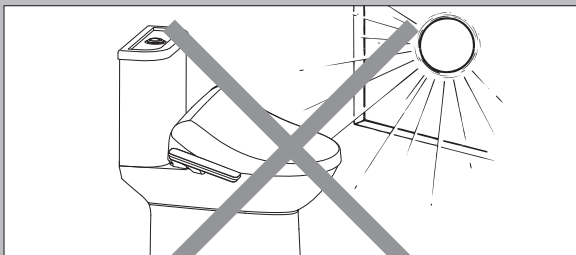

Do not roughly open and close the seat and toilet lid.

※ Risk of crack or malfunction like electric leakage.

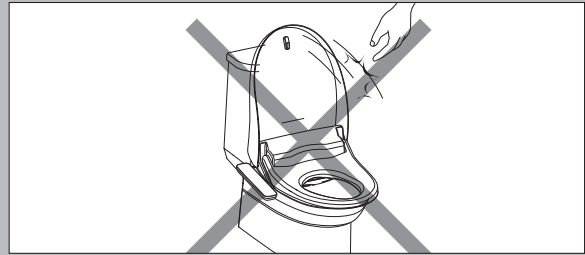

Do not put your finger or other things into the cover of dryer or nozzle.

Do not block the outlet of warm air.

※ Risk of personal injuries like injury to the finger or malfunction.



Do not clean the parts made of plastics like seat and toilet lid with dry cloth or toilet paper.

※ Risk of scratch.

Do not connect the product to the power when it is in non-level installation such as tilting, inversion and so on.

※ Risk of immediate damage of the product.

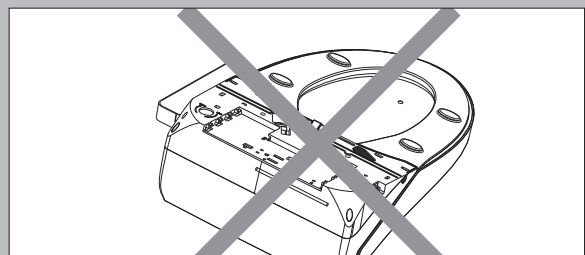

CAUTIONS BEFORE INSTALLATION

CAUTIONS BEFORE INSTALLATION

■ Packing Material List

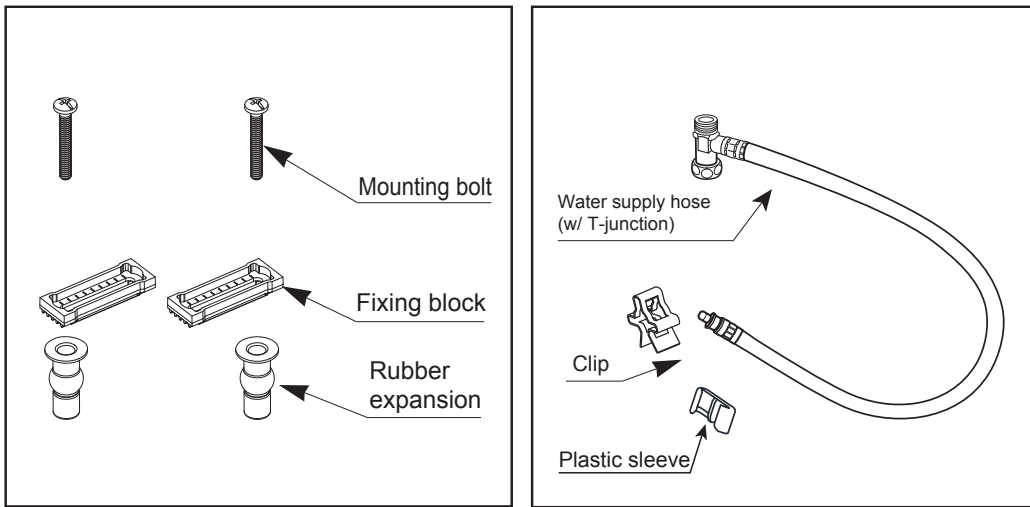
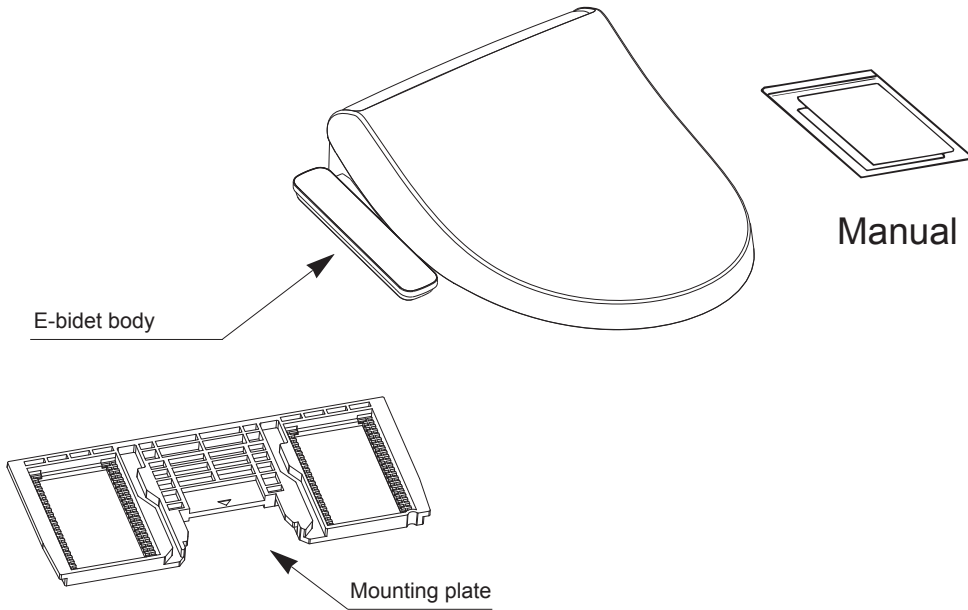

■ Installation Tools for Preparation

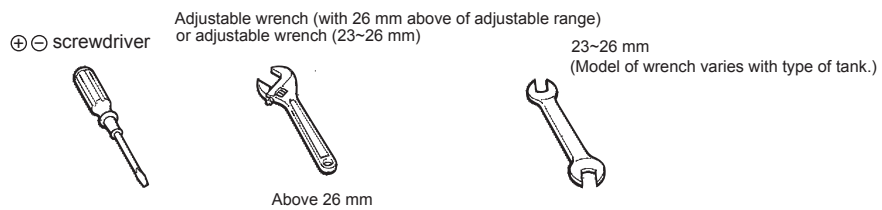

■ Power Supply and Water Supply

- What kind of power socket should be used?
- Please use standard power socket with AC 220 V, 50 Hz and Min. power 650W.
- Power cord length is 1.0 m.

The power socket should be placed in a dry part within the length of the cord and higher than the floor.

- Ensure that socket ground wire should be connected correctly, otherwise, contact electrical installation company to perform work.

※ Before installation is finished, do not insert power plug into socket, to avoid malfunction.

※ Risk of electric shock if power supply not grounded. Power supply grounded here indicates that the ground wire of distributor uses copper wire with a diameter of 1.5 mm or more when ground resistance is less than 100 Ω.

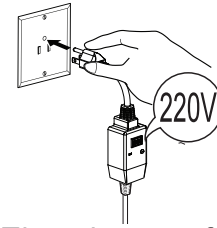

The pictures for reference only

- What kind of water should be used?

- Water supplied must be connected to city water.

If recycled water, industrial water, well water etc. are used, it may reduce durability of electrical and mechanical components, resulting in malfunction.

- Water pressure supplied should be maintained between 0.06 MPa (0.6 kgf/cm²) and 0.75 MPa (7.5 kgf/cm²).

Please contact the shop if the pressure is not within above range.

- Please take water from toilet supply valve.

Contact the shop if the valve is installed on flush valve type toilet or water is taken from other places, or supply valve of toilet is connected with recycled water pipeline.

■ Adaptive Toilet

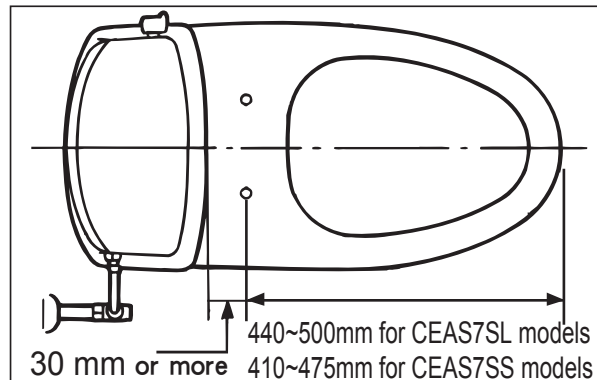
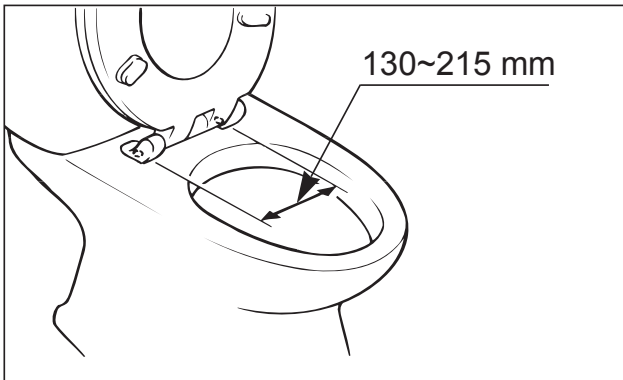

■ Installation Space Range

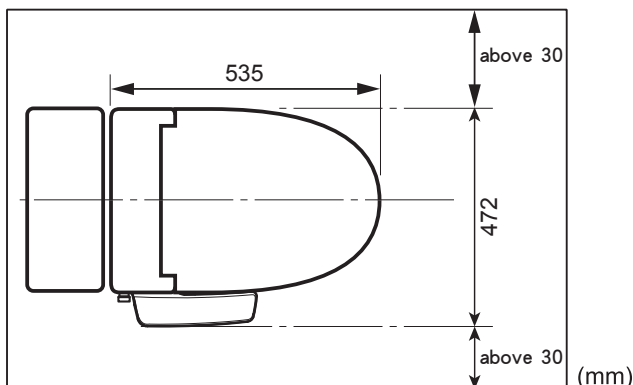

COMPONENTS NAME

■ Integral Diagram

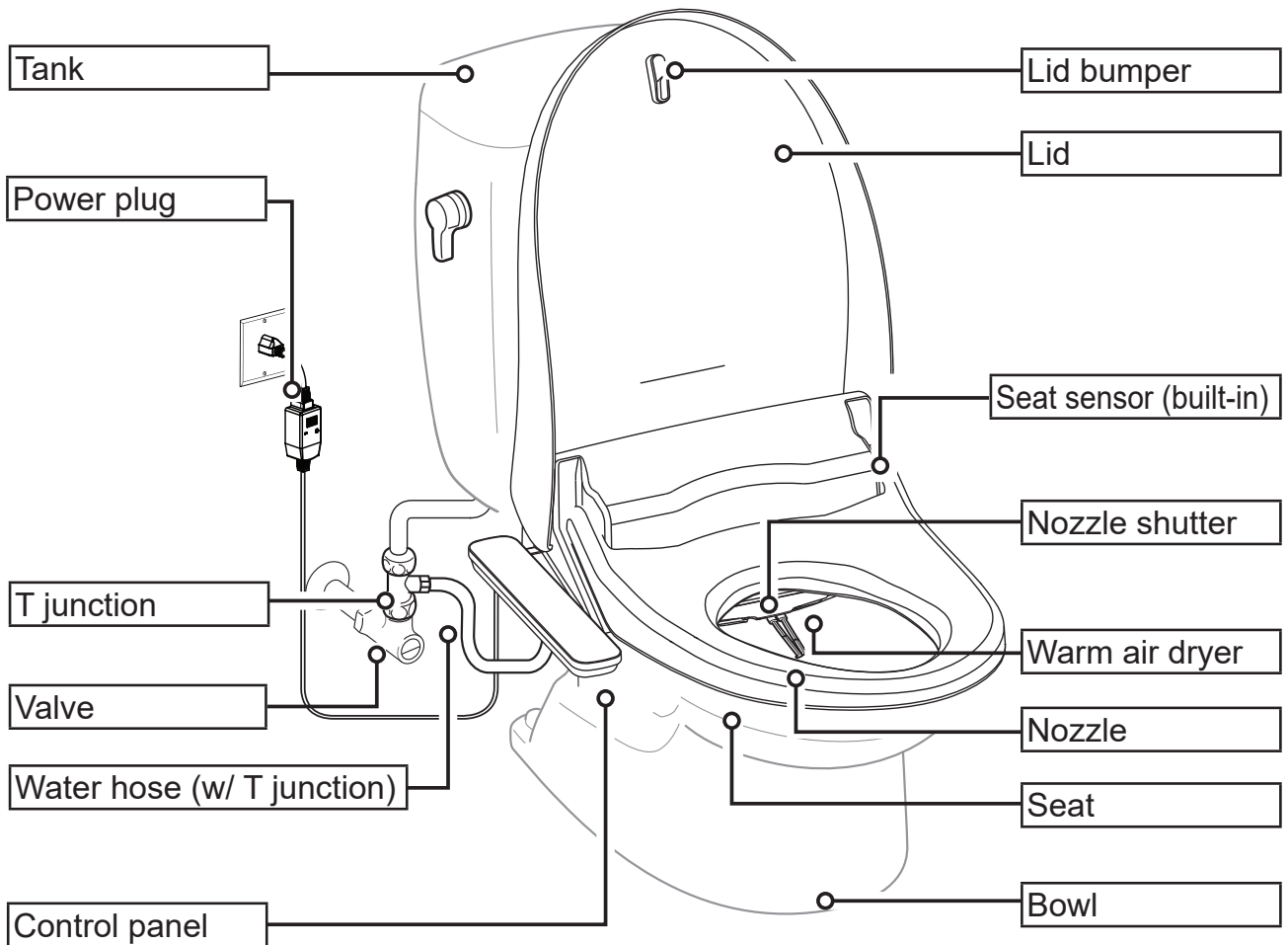

COMPONENTS NAME

■ Strainer

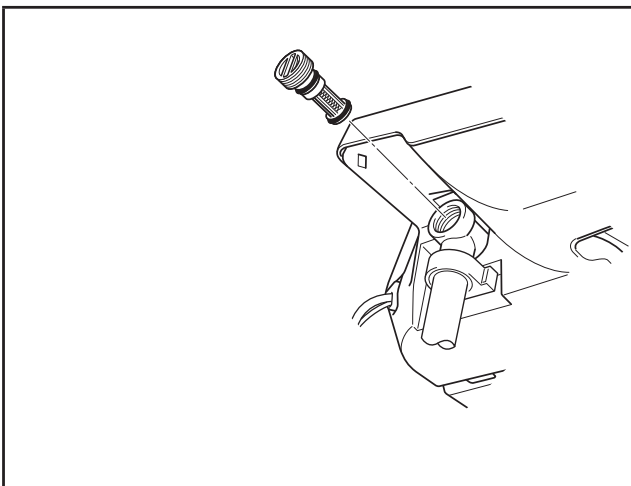

■ Drainage valve of warm water tank

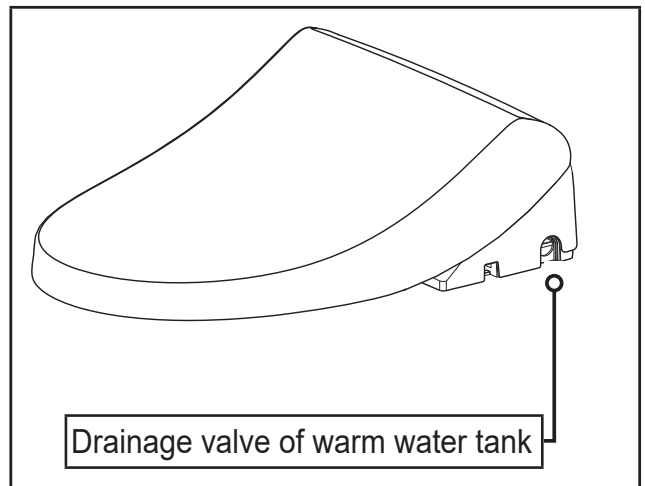

■ Operation

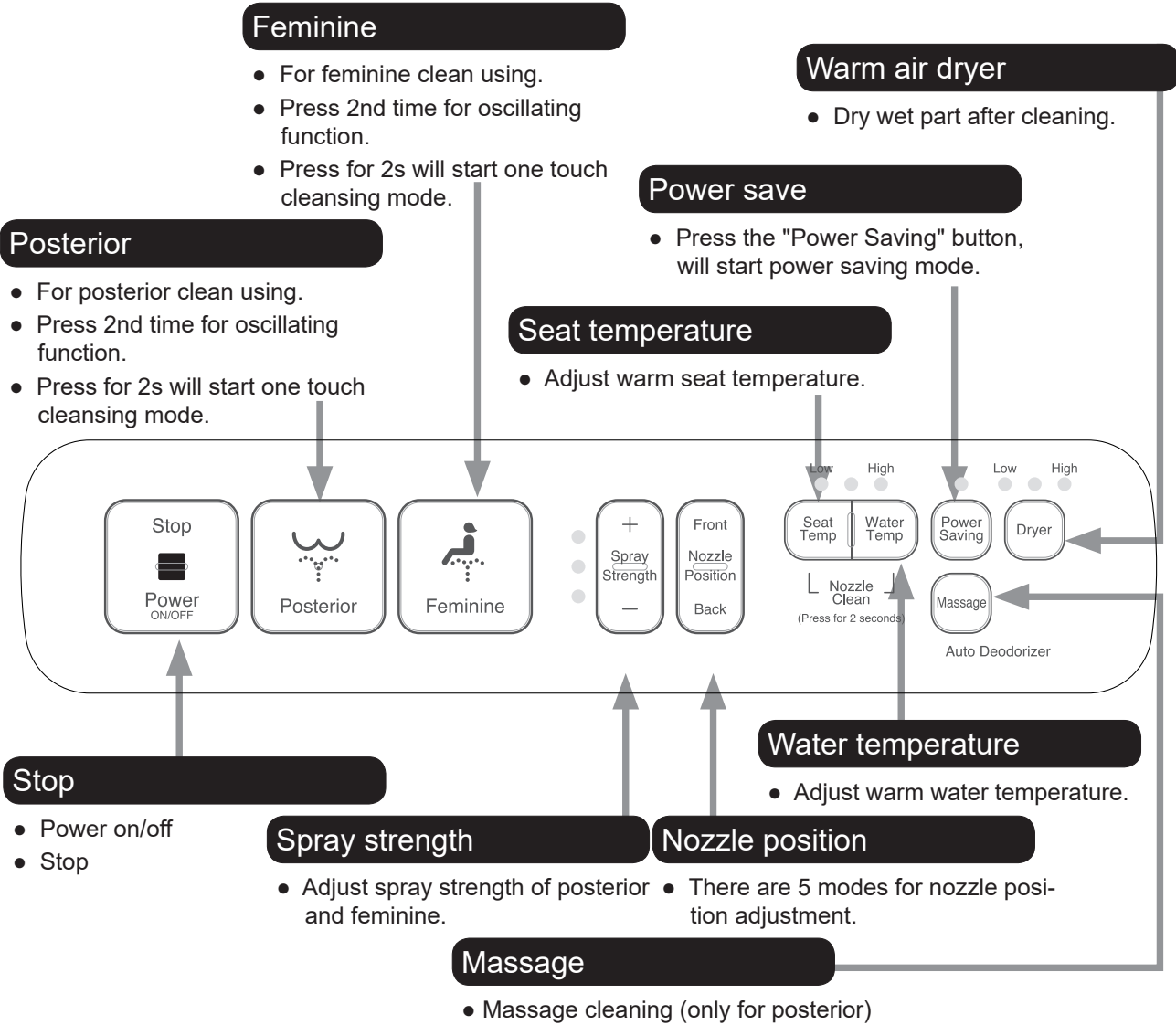

■ Mounting plate & locking handle

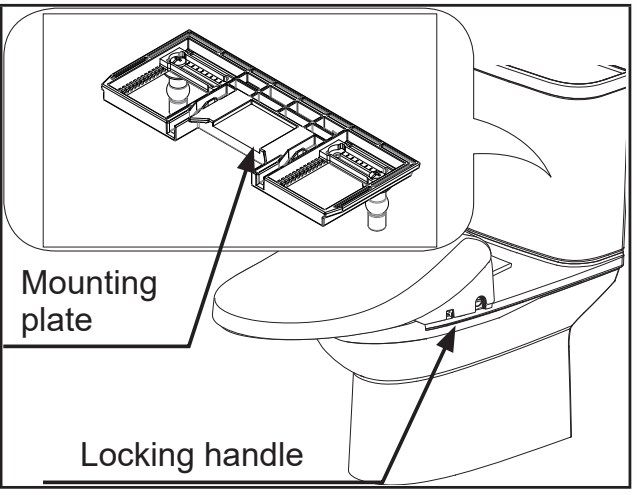

■ Seat sensor

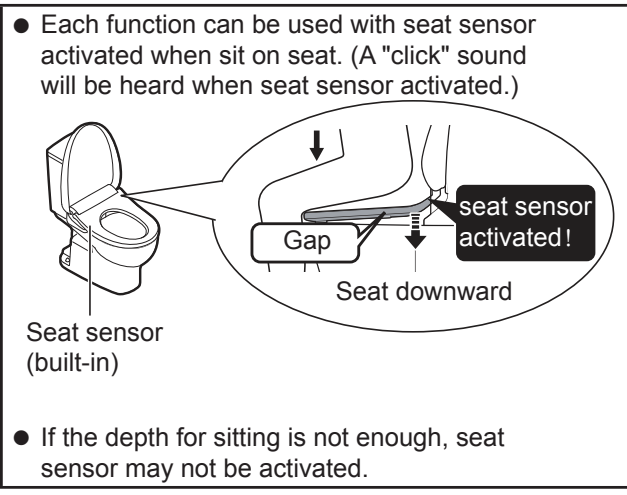

Installation

■ Installation of E-bidet

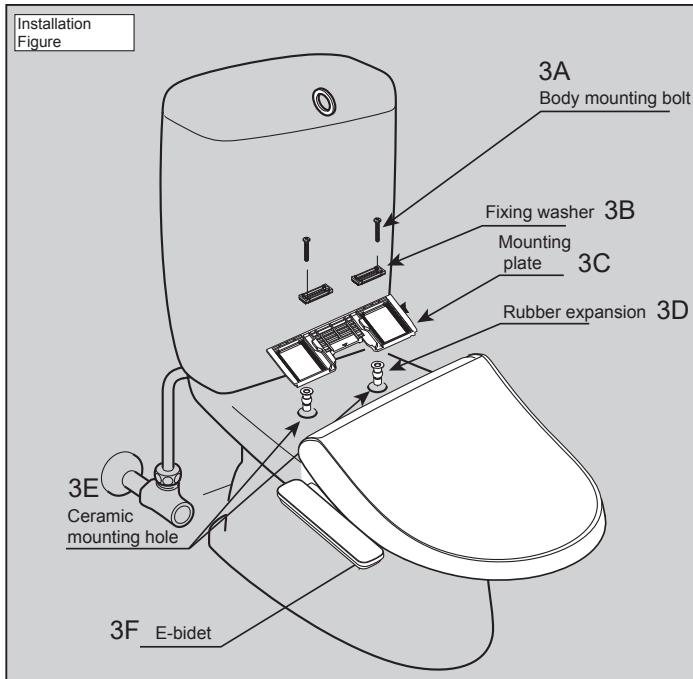

1. Remove the old E-bidet

- (1) Remove 3I, 3J, 3K underneath of the bowl.
- (2) Take up 3G and remove it together with 3H.

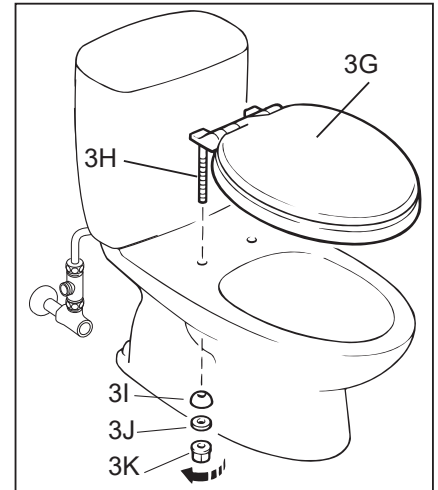

Installation

2. Install 3C to bowl.

- (1) Insert 3D into 3E of bowl.

- (2) Pre-secure 3C to bowl with 3A after inserting 3B into 3C.

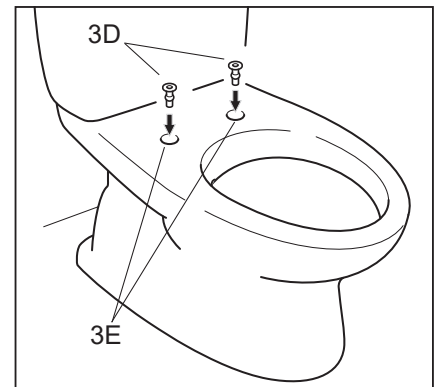
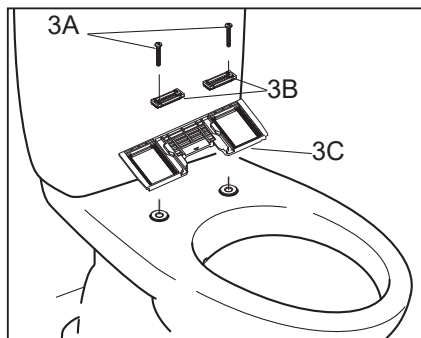

3. Install the E-bidet

- (1) Put 3F in front of 3C with 3F and 3C center aligned.
- (2) Push body backward slowly until it reaches the bottom with a slight "click" sound heard.

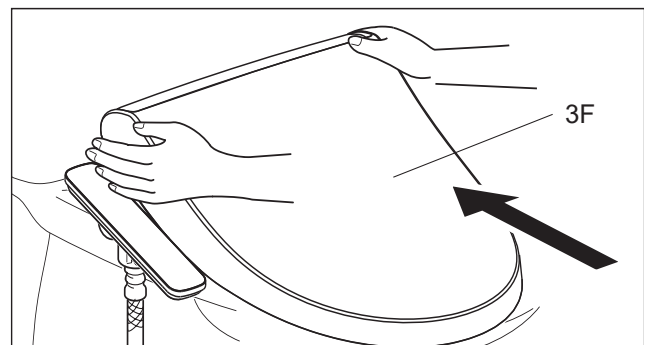
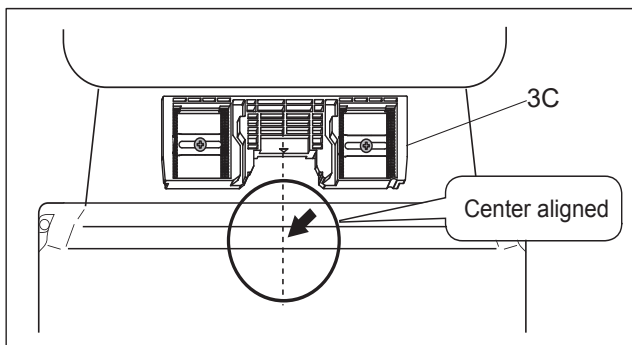

■ Installation of E-bidet water supply hose

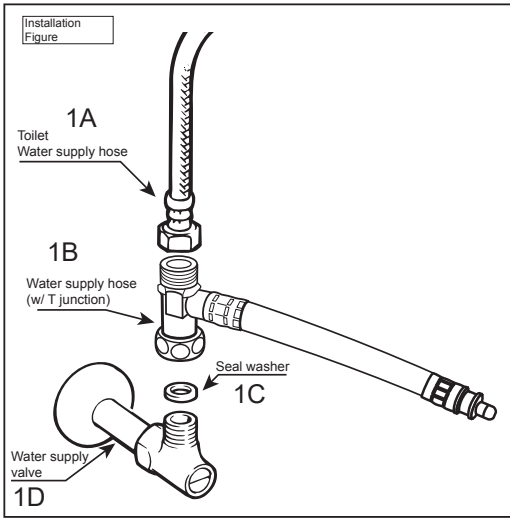

1. Remove 1A after 1D is closed.

※ There will be small amount of water leakage during removal, so put a piece of cloth, etc. under it.

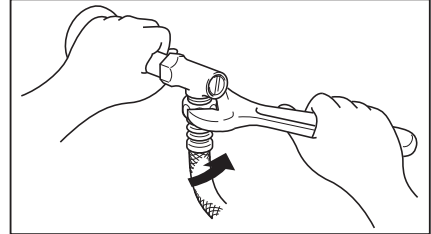

2. Install 1B to water supply valve.

(It is recommended that tightening torque should be 10~15N.m (100~150kgf.cm))

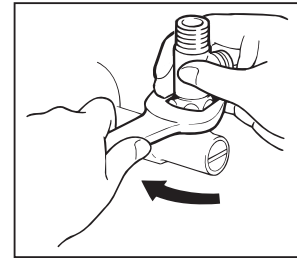
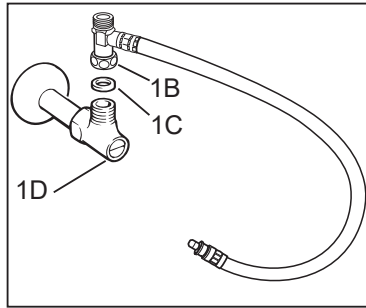

3. Install 1A.

※ Be careful not to twist 1A.

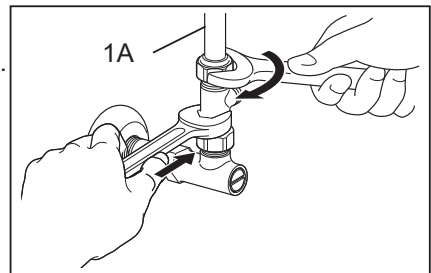

■ Installation of body water supply hose (body side)

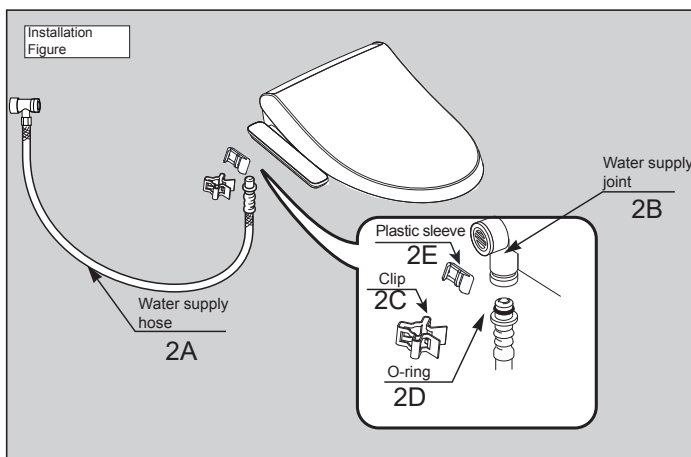

1. Insert 2A into 2B.

2. Clamp 2C into 2A and 2B.

※ The side of clip 2C with round corner faces downward.

3. Rotate 2C by 90°.

※ After clamping 2C, fully rotate to confirm it is clamped into position.

4. Clamp 2E into 2C from top to bottom.

※ When 2E is clamped into position, a "click" sound is heard.

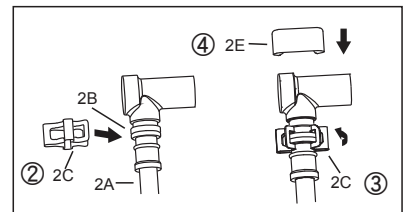
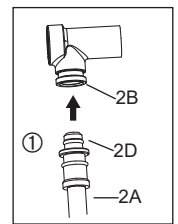

4. Adjust the installing position of E-bidet to front, rear, left and right

- (1) Adjust the installing position to front, rear, left and right, so that 3F edge matches with ceramic edge curve of bowl.
- (2) Press locking handle (3L) on right side, slide 3F forward to remove it.

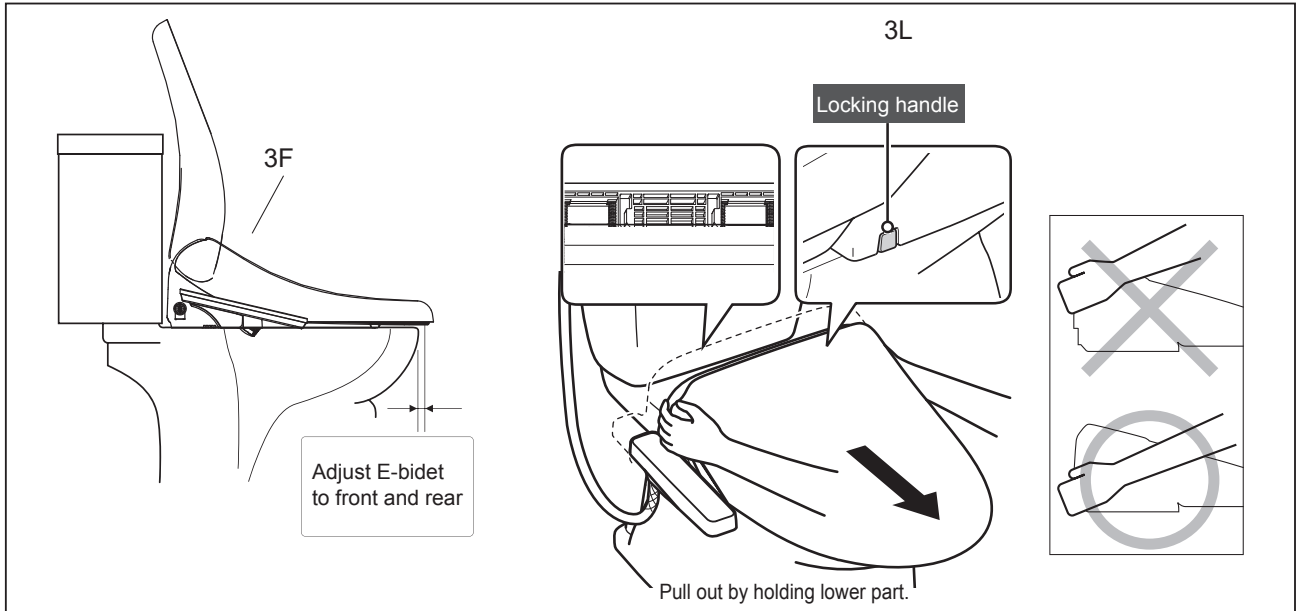

5. Fix E-bidet securely

- (1) Adjust 3C forward and backward and then tighten 3A.
 ※ Reference torque: 1.0~3.0 N.m (about 10-30 kgf.cm).
- (2) Place 3F at front of 3C to make 3F and 3C align center.
- (3) Slowly push 3F backward until it reaches bottom and a slight "click" is heard.
 ※ Slightly shake 3F to front, rear, left and right to make sure the body is fixed securely.

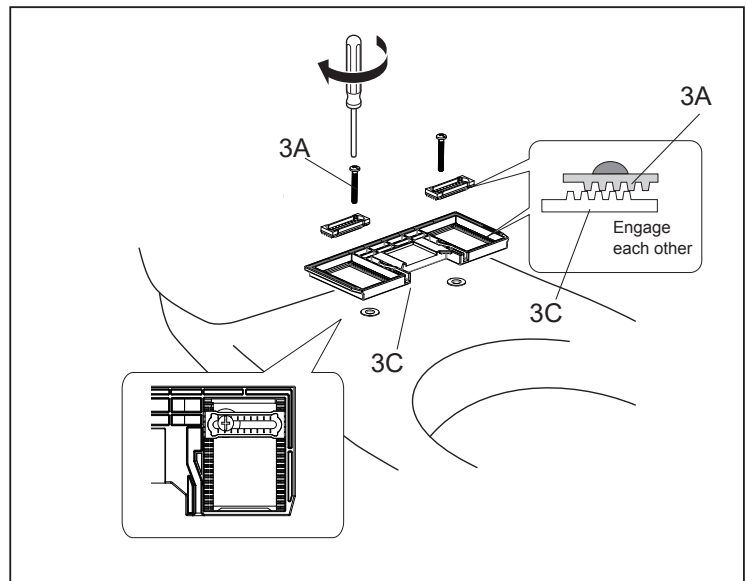
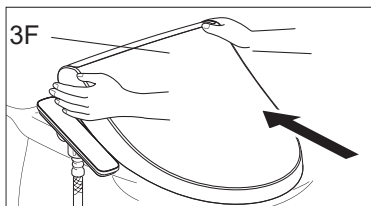

Pay attention to followings during installation:

- (1) Please note the front and rear directions of mounting plate.
- (2) Please note the installation direction of small sliding block.

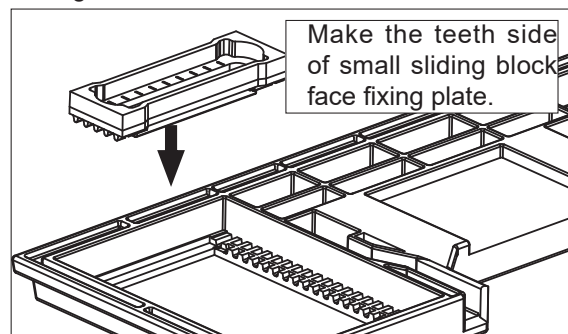
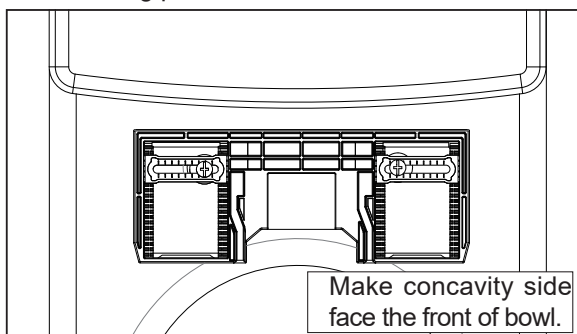

■ Power on confirmation

1. Connect the power plug to plug seat.
2. Confirm that whether the power is on.
 - (1) Confirm water temp. and seat temp. indicators on side control panel turn on.
 - (2) To prevent dry burning of warm water tank, before the test run is done, press Power button to turn off all indicators.

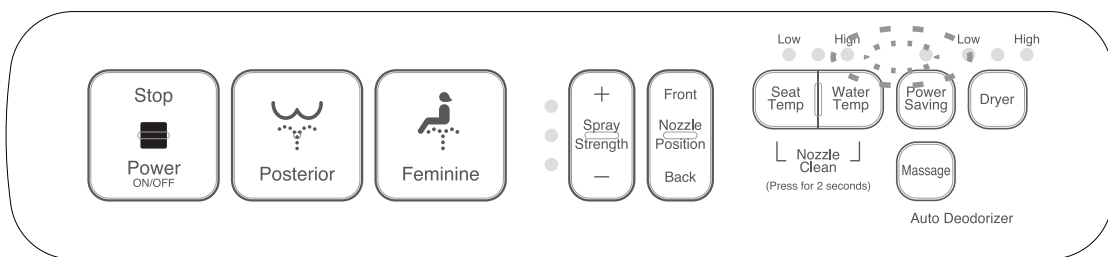
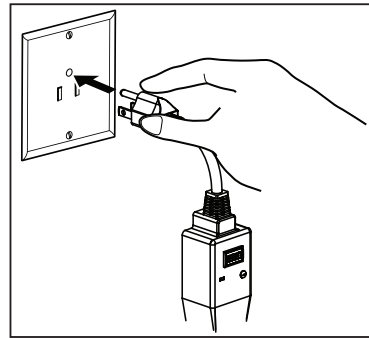

■ Test run

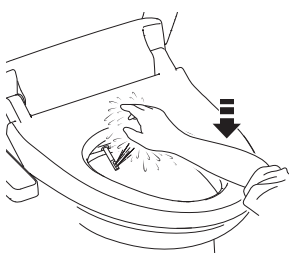
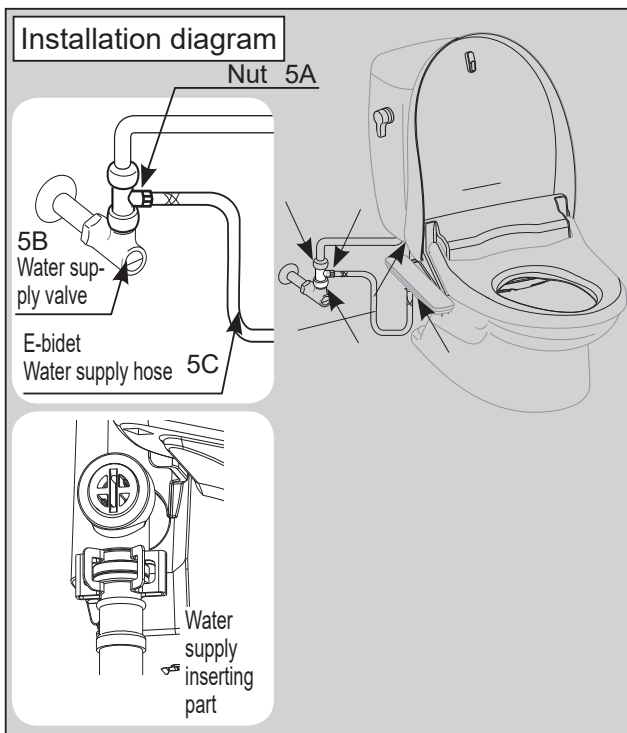

1. Rotate 5B in anti-clockwise direction to its original position to turn it on, and supply water to water tank and E-bidet.

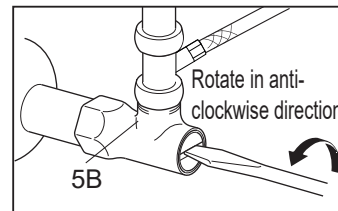

2. Operate flush handle of bowl to confirm there is no water leakage from each part.
 - ※ If there is leakage, retighten nut and install again.
3. After water tank is filled with water, confirm water supply is stopped.
 - ※ If water tank is not filled with water or water supply does not stop, confirm if flush valve or inlet valve is functioning properly.
4. Confirm if shower and bidet function operate normally.
 - 1) Press the seat with your hand to enter sitting state.
 - 2) Respectively press Posterior and Feminine buttons to confirm water flows from the nozzle smoothly.
 - 3) Press Stop button.
5. Confirm temperature adjustment function operates normally.
6. Around 15 minutes later, seat surface become warm and warm water can spray out.

OPERATION INSTRUCTION

Preparation and Confirmation before Using

If this is your first time to use E-bidet, the following steps must be confirmed.

※ Methods of turning on/off the water supply valve written in this guide may be different from the actual circumstances.

STEP

1

Confirm that whether the water supply valve has been turned on.

※ If water supply valve is off, please rotate in anti-clockwise direction to turn it on.

Water supply valve

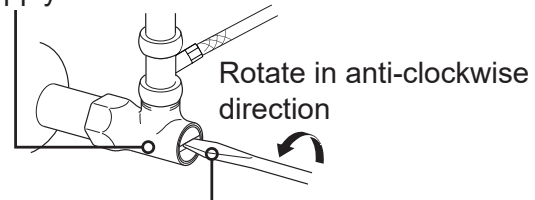

Flat-blade screwdriver

STEP

2

Connect the power plug to plug seat.

Connect power plug to plug seat of AC 220 V.



STEP

3

Power

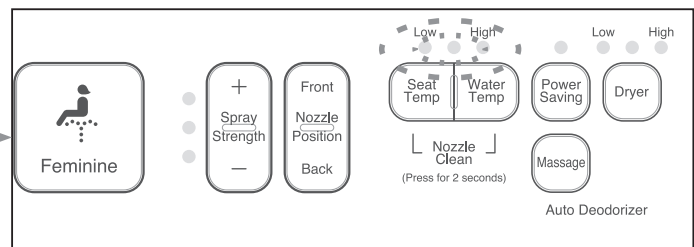

(1) Check if the indicators (green) on control panel turn on.

※ Press Power button for 6 seconds or above to shut down the E-bidet, press Power button for about 1 second to turn on the power.

※ Check the indicators of water temp. and seat temp. turn on or not to judge power on/off.

(2) Confirm water temp., seat temp. and dryer indicators turn on or not.

**STEP****4****Testing shower function.**

- (1) Press the seat to enter sitting state (press force is more than 12 N).
- (2) Press Posterior button.
- (3) Cover the front of nozzle with left hand after nozzle is extended to block water flow.

If this is your first time to use the product, it will take 1 - 2 minutes to inject water to warm water tank.

Water cannot be heated to set temperature immediately, and warm water may spray out after about 5 minutes.

- (4) Press STOP button or move your right hand from the seat sensor zone to stop shower.

Please read the operation method, and confirm other functions.

※ Seat sensor is available to sense if there is anyone sitting on the toilet seat. When press force is more than 12 N, shower, bidet, deodorization or dryer function will work.

STEP**5****Adjust seat temperature.**

- (1) Press Seat Temp. button to adjust seat temperature.
- (2) The indicator will be switched each time the button is pressed, achieving appropriate temperature.

※ Seat temperature cannot be immediately heated to warm state. If activating heating function in 10 - 15 minutes ahead, it will be more comfortable to use.

※ Each time the button is pressed, the indicator will be switched between "Off (indicator not turn on)", "Low", "Mid", and "High" state.

※ Initial setting is "Mid" when you first time using.

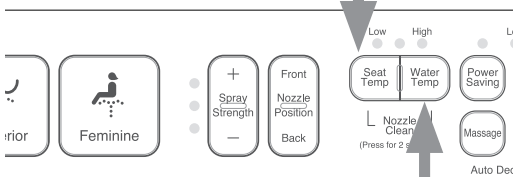
**STEP****6****Adjust warm water temperature.**

- (1) Press Water Temp. button to adjust water temperature.
- (2) The indicator will be switched each time the button is pressed, achieving appropriate temperature.

※ Wash water temperature cannot be immediately heated to warm state. If activating heating function in 10 - 15 minutes ahead, it will be more comfortable to use.

※ Each time the button is pressed, the indicator will be switched between "Off (indicator not turn on)", "Low", "Mid", and "High" state.

※ Initial setting is "Mid" when you first time using.

Basic Operation

Seat sensor is available to sense if there is anyone sitting on the toilet seat. Without sitting on, shower, bidet, deodorization or dryer function will not work.

■ Deodorization function is activated when the unit is occupied (auto deodorization)

※ Only for CEAS7SL1-0100510P0, CEAS7SL1-0100510A0
CEAS7SL1-0100510V0, CEAS7SL1-0100510M0
CEAS7SS1-0100510H0 model.

(1) Auto deodorization is activated when people sit on.

※ Deodorization fan is working under the "auto mode" and remove the odor in the bowl.



(2) Stop deodorization

※ It automatically stops after user leaves.

※ If sitting on the seat over 1 minute, auto deodorization will delay to close by 1 minute, otherwise it will close immediately.



Shut off auto deodorization

Press and hold both Stop and Feminine buttons for more than 2 seconds to shut off auto deodorization.

After setting, all indicators will flash once.

※ To restart auto deodorization, also press and hold both Stop and Feminine buttons for more than 2 seconds. After setting, all indicators will flash once.

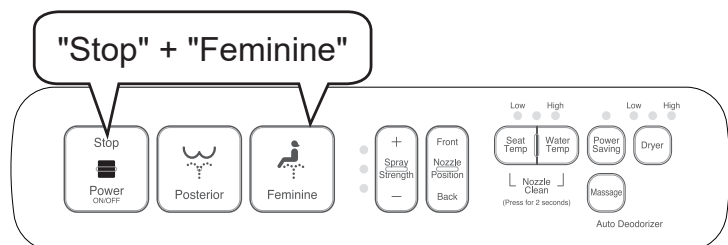

■ Shower ▶ Oscillating

Press Posterior button.

Water sprays out from front of nozzle to clean posterior.

Press again will enter front and rear oscillating status, and the oscillating range will be expanded. Press for the third time will stop oscillating, and resume to shower status.

Press "Stop" button to stop.

■ Bidet ▶ Oscillating

Press Feminine button.

Water sprays out from front of nozzle to clean feminine.

Press again will enter front and rear oscillating status, and the oscillating range will be expanded. Press for the third time will start wider range clean.

Press "Stop" button to stop.

※ Gentle foam cleaning mode designed for bidet is more comfortable.

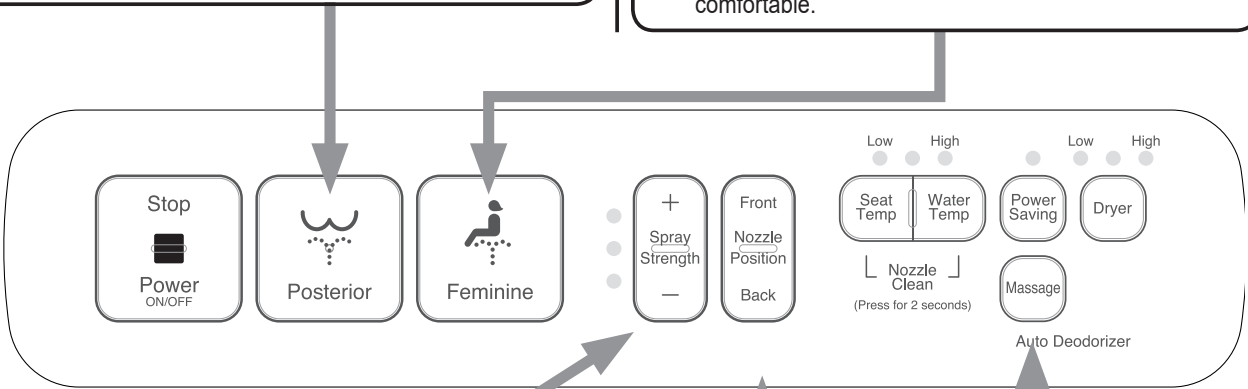

■ Spray strength adjustment

When it is necessary to change the spray strength, press "+" or "-" button to adjust.

The indicator will change once every time the button is pressed, and you can set to a proper spray strength.

■ Massage

Press "Massage" button to start massage function under shower function working.

With massage function working, press "Massage" button again to stop massage function.

※ Massage function is not available for bidet.

■ Nozzle position

Press "Front" or "Rear" button of Nozzle Position.

There are 5 modes for nozzle position adjustment.

- The Shower and Bidet have auto stop after 2 minutes function.
- Please deeply sit on the seat. Deeply sitting on the seat can prevent water spraying to everywhere as much as possible.
- There is auto nozzle cleaning function, which can automatically clean the nozzle before and after the shower and bidet.
- Water flows from nozzle: Before and after the shower, water may flow from the nozzle. This phenomenon is normal for the functions, rather than a malfunction.

■ Warm air dryer

1. Press "Dryer" button.

Warm air is blown out to dry the wet parts due to shower, massage or bidet.

2. Press "Dryer" button again can switch dry temperature.

The indicator will change once every time the button is pressed, and you can set to a proper temperature.

※ Each time the button is pressed, the temperature will switch in the order of "Off", "Low", "Mid" and "High".

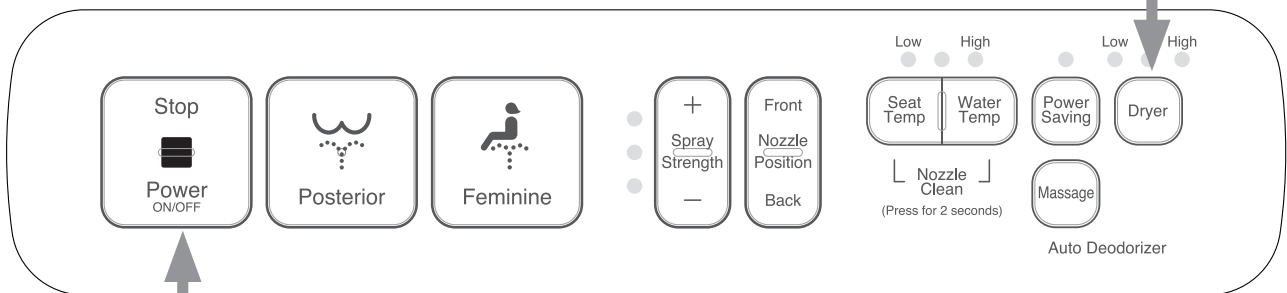

3. Press Stop button to stop.

※ Warm air dryer has auto stop after 4 minutes function.

Reference

- After shower, bidet or massage etc., if toilet paper is used to gently remove the water drops before using "Dryer" function, drying speed will be much faster.

■ Stop (Power ON/OFF)

1. Stopping: press "Stop" button can stop "shower", "bidet" or "dryer" function.

※ Auto stop after 2 minutes function is available for shower and bidet.

2. Power ON/OFF:

- ① Shut down: with power ON, press "Power ON/OFF" button for more than 6 seconds will shut down the product, and all indicators on operated part will go off.
- ② Starting: with power OFF, press "Power ON/OFF" button can restart the power supply.

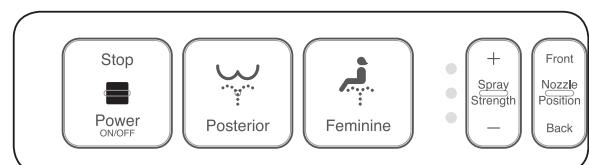

Other Function Settings

■ One Touch Cleaning

One touch auto Posterior clean.

- ※ Pre-set water temperature and air temperature to proper levels before starting the function. Press Stop button can stop this function after starting.
- ※ One touch cleaning function is suitable for children and old people.

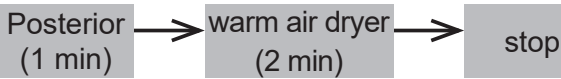

One touch auto Feminine clean.

- ※ Pre-set water temperature and air temperature to proper levels before starting the function. Press Stop button can stop this function after starting.
- ※ One touch cleaning function is suitable for children and old people.

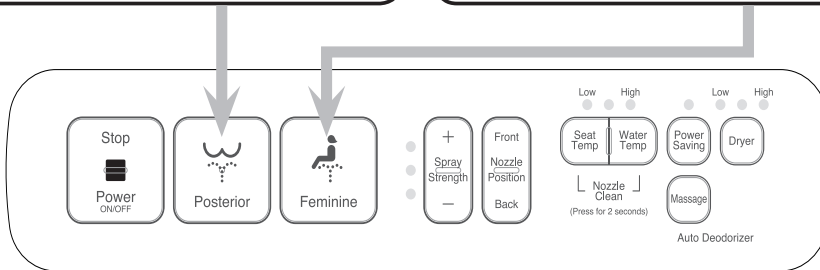
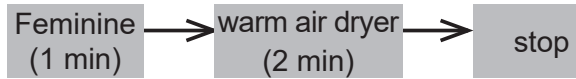

■ To prevent low temperature burn

Press and hold "Seat Temp" and "-" buttons for more than 2 seconds (all LEDs will flash).

When the seat is occupied, seat heater turns off automatically. This can effectively prevent low temperature burns to corresponding parts.

- ※ Use the same methods to resume to initial setting.
- ※ The function is not available for factory settings.

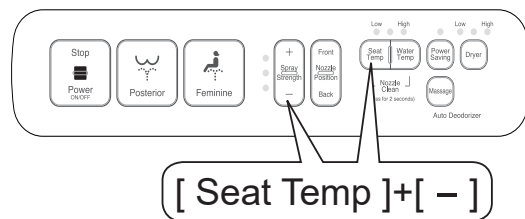

■ Resume to factory settings

Press and hold Feminine button + "+" and "-" button of Spray Strength simultaneously for more than 2 seconds.

■ Factory settings

Function explanation		Factory settings
Deodorizer	Auto deodorizer	On
Power saving	High Efficiency power saving	Off

Function explanation	Factory settings
Warm water temperature	Mid
Seat temperature	Mid
Auto off of seat heater	Off
Warm air dryer	Starting temperature of warm air Mid
Spray strength	3 modes
Warm water temperature	3 modes
Seat temperature	3 modes

■ Power Saving

Power saving function is divided into one touch power saving (8 hrs) and high efficiency power saving (always). Using high efficiency power saving and one touch power saving simultaneously, the power saving effect is more significant. The initial setting is "close".

One Touch Power Saving (8 hrs)

If the product is not used during night time etc., press POWER SAVING button will cut off power of both warm water and seat heater for up to 8 hours, so as to reduce unnecessary power consumption. After 8 hours, warm water temperature and seat temperature resume to the set conditions. The function automatically circulate every 24 hours (in same period of each day).

Press [Power Saving] button.

※ The Power Saving indicator on the operation section is on.

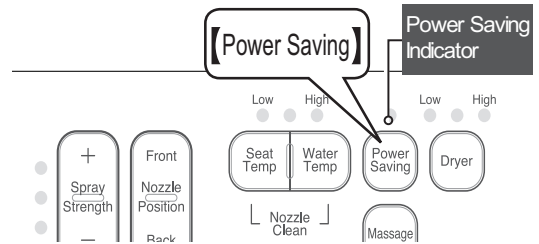
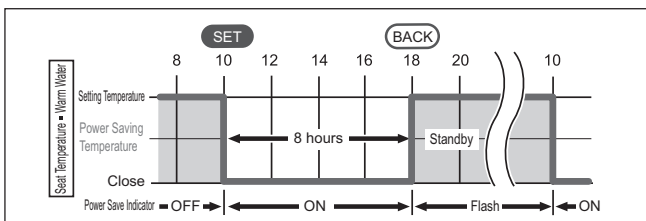

※ After 8 hours, it is in "standby" condition, power saving indicator switch to flash.

(Reference)

- When power off or unplugging the power plug, one touch power saving backs to initial setting.

How to release one touch power saving function

Press [Power Saving] button.

※ High Efficiency Power Saving (always)

High Efficiency Power Saving (always)

When the product is not in use, it lowers the temperature of warm water and seat to control power consumption.

※ When the product is not in use, it enters power saving mode automatically.

Press [Water Temp] and [Power Saving] button, and continues for 2 seconds or more.

※ Power saving indicator of displayed part flashes.

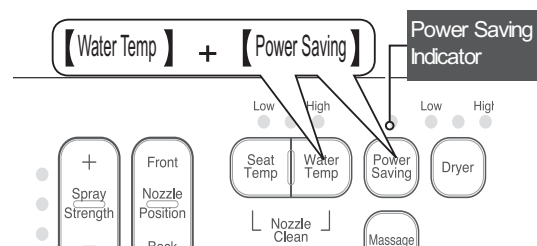
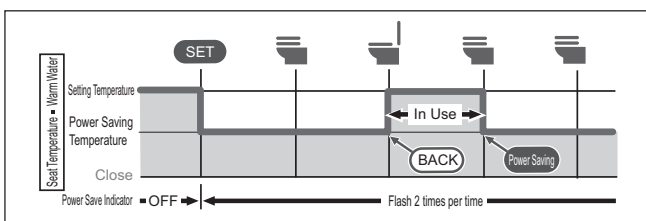

※ If it uses with one touch power saving together, when one touch power saving is operating (8 hrs), Power Saving indicator on the operation section is on, and when one touch power saving is in standby (16 hrs), Power Saving indicator flashes 2 times for each time.

How to release high efficiency power saving function

Press [Water Temp] and [Power Saving] button, and continues for 2 seconds or more.

※ Power saving indicator of displayed part turns off.

(Reference)

- Due to the temperature of warm water and seat will lower when saving power, you may be feel little cool. Please release power saving mode then.
- When power saving function is not in use, close the lid also has power saving effect.

■ Seat temp. 3 → 5 modes expansion function

Press "Seat temp." and nozzle position "Front" for 2s or above can switch seat temperature adjustment from 3 modes to 5 modes.

- ※ After setting, all indicators will flash once.
- ※ The "Low" and "Mid" indicator will both light on when seat temperature is in the middle of "Low" and "Mid", while "Mid" and "High" indicator will both light on when seat temperature is in the middle of "Mid" and "High" temperature.

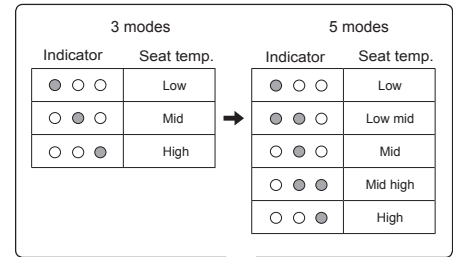

Resume to initial setting

Press "Seat temp." and nozzle position "Front" for 2s or above.

- ※ After setting, all indicators will flash once.

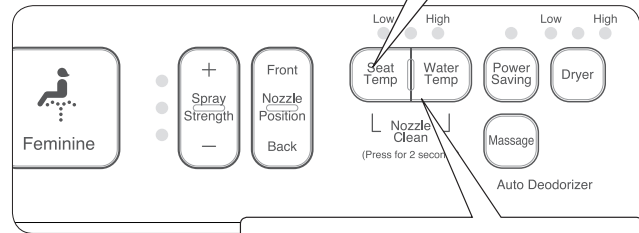

■ Warm water temp. 3 → 5 modes expansion function

Press "Water temp." and nozzle position "Back" for 2s or above can switch warm water temperature adjustment from 3 modes to 5 modes.

- ※ After setting, all indicators will flash once.
- ※ The "Low" and "Mid" indicator will both light on when water temperature is in the middle of "Low" and "Mid", while "Mid" and "High" indicator will both light on when water temperature is in the middle of "Mid" and "High" temperature.

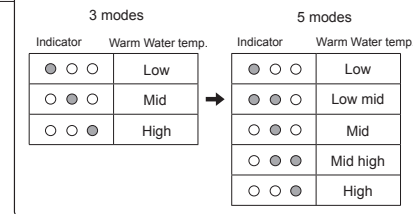

Resume to initial setting

Press "Water temp." and nozzle position "Front" for 2s or above.

- ※ After setting, all indicators will flash once.

■ Spray strength 3 → 5 modes expansion function

Press "Water temp." and spray strength adjustment "-" for 2s or above can switch spray strength from 3 modes to 5 modes.

- ※ After setting, all indicators will flash once.
- ※ The "Low" and "Mid" indicator will both light on when water temperature is in the middle of "Low" and "Mid", while "Mid" and "High" indicator will both light on when water temperature is in the middle of "Mid" and "High" temperature.

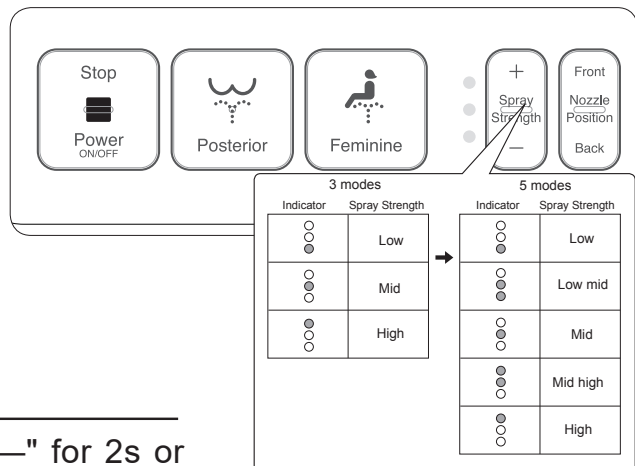

Resume to initial setting

Press "Water temp." and spray strength "-" for 2s or above.

- ※ After setting, all indicators will flash once.

Information to the User

Information to the User

Water comes out from nozzles

When the seat is occupied or the cleaning functions are activated, there may be water coming out from nozzles. Such phenomenon is the design of the product rather than malfunction.



※ Except the phenomenon described above, if the water continuously comes out, please turn off water supply valve, unplug the power plug from the plug seat, and contact dealer or aftersales department via phone or fax.

Noise from radio and TV set

The product may jam the signal reception of radio and TV set.



In such circumstance, please move the radio and TV set to somewhere free from jamming.

Moisture condensation

Due to different temperatures or humidity between room temperature and surface of seat and lid, there may be water drops (moisture condensation) on the surface of seat and lid. In order to prevent moisture condensation, please maintain the ventilation of the toilet as much as possible. In case of moisture condensation, please mop by dry cloth.

※ Water of moisture condensation may leave trace on the floor or damage the floor.

Tips for power saving

The following operation can effectively save energy.

- After using the lid, close it.
 - Do not blindly set both seat and water temperatures to high level, which should be set to a comfortable level.
 - Please adjust temperatures in accordance with temperatures of four seasons.
 - When you are out, use available power saving function as much as possible.
 - Please disconnect the product when you go out for a long time.
- ※ Please take anti-freezing methods when freezing may occurred.

Abnormal smell in warm air at the very beginning

When the product is used from the very beginning, there may be slight abnormal smell when dry function activates, which will vanish later soon.

Seat sensor is available

If the seat is not occupied, even press the "Posterior" or "Feminine" button in error, there will not be spraying water, because seat sensor is available to the product. As long as the seat is not occupied, shower, bidet and warm air dry will not be activated.

Incorrect seated posture or used by children, seat sensor may not operate, at this time, please adjust seated posture according to seat sensor position.

※ In case of power off when the seat is occupied, functions like shower is not working when the power is just restored. In such circumstance, please leaves the seat and then sit down again in approximately 1~2 seconds.

A gap between seat and surface of rim

Due to seat sensing unit is built into right side of seat hinge, so design of seat is up and down displacement structure may lead to a certain gap between seat rubber cushion.

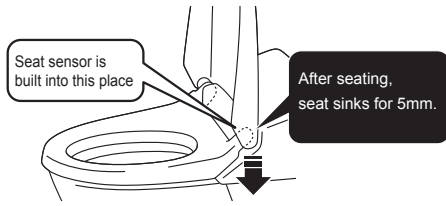

Slow close seat and lid

In order to prevent the seat and lid from closing suddenly, slow close function is available to the product, which allows it to close slowly.



※ Caution: force to close the seat and cover may caused product mal-function.

CLEANING AND CARE

Daily Cleaning and Care

■ Cleaning and care of seat, lid and protective cases (plastic parts)

● Use a soft damp cloth to clean.

Stain will be hard to remove if it cannot be removed timely. Use water to clean stain.

Clean the unit with water can prevent the occur of static electricity, which may result in attachment and nigrescence of stain.

- ※ It is very easy to remove E-bidet, and it can be removed from toilet, which makes it convenient to clean the part between toilet and E-bidet.
- ※ Please keep press power on/off button to cut power supply when clean and care the product.
- ※ Clean the nozzle need under power on condition.

Caution

Do not use "chloride detergent, acid detergent or disinfectant" to clean the electronic toilet seat.

- ※ Risk of product malfunction or damage.

Do not clean with dry cloth or toilet paper.

- ※ Risk of scratches can be caused.

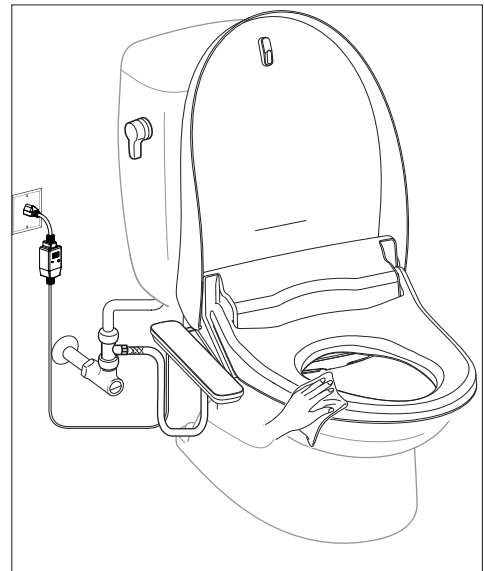

CLEANING AND CARE

■ Cleaning and Care of Nozzle

Automatic clean:

Under power on and seat occupied condition, press "Seat Temp" + "Water Temp" buttons simultaneously for 2s, nozzle will start self-cleaning.

Manual clean:

Under power on and leave seat condition, press "Seat Temp" + "Water Temp" buttons simultaneously for 2s, nozzle shutter will open, please pull out the nozzle and use sponge to clean the nozzle if there is any dirt. After cleaning, press "Stop" button retract the nozzle.

- ※ Don't force pull or bend nozzle.
- ※ The front part of nozzle can be replaced individually. Please contact official after service for detail.

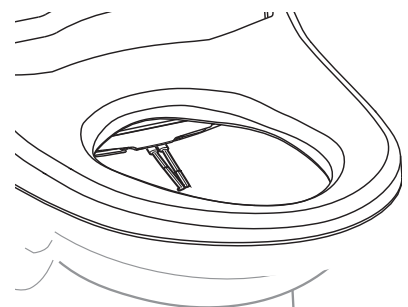
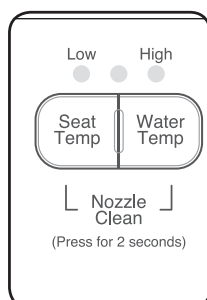

Cleaning after Removing Lid

The lid can be removed, so that the lid and the internal parts can be cleaned.

Remove lid

- 1 Press "POWER ON/OFF" button for about 6s to turn off power and confirm that all the indicators are off.

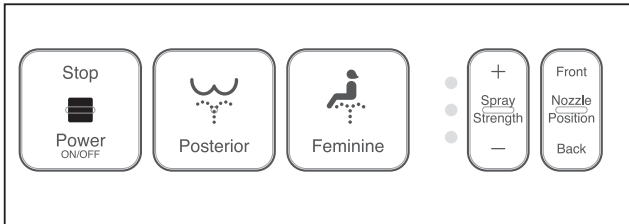

- 2 Hold the lid with both hands and pull it outwards on the right side of the unit so as to separate the lid from the E-bidet.

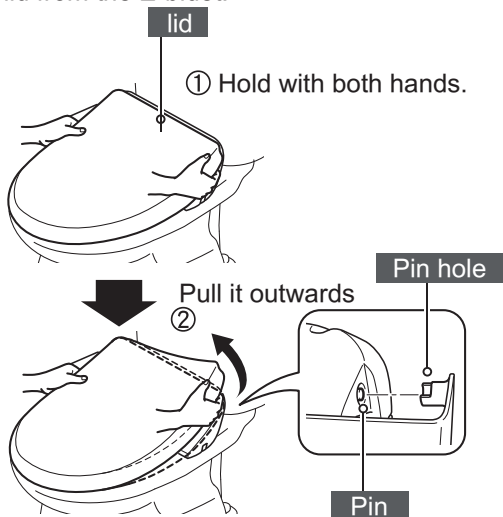

- 3 Lift the lid and move it to the left and then remove it.

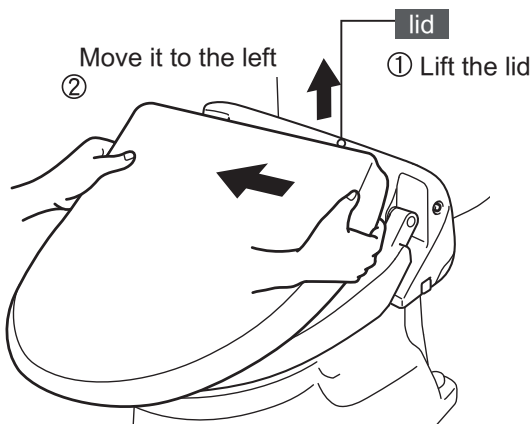

Install lid

- 1 Align the pin hole on the left of the lid with the pin on the left of the unit, and then insert.

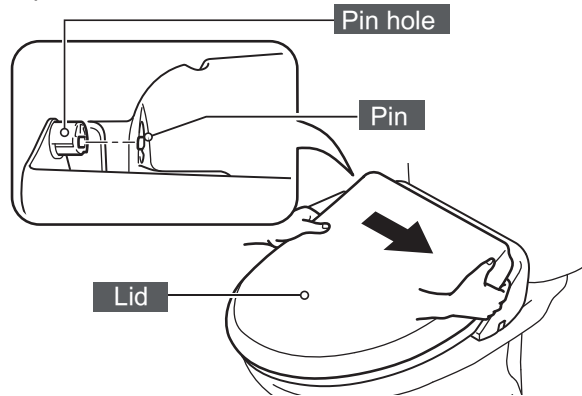

- 2 Pull the pin hole on the right of the cover lid outwards, and then install the lid after alignment.

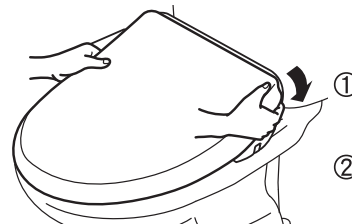

- 3 Press "POWER ON/OFF" button for more than 1s to connect to the power and confirm that all the indicators are on.



[CAUTION]

- Do not apply too much force to the lid.
 - ✗ Risk of lid damage.
- Do not lift the lid when the lid is removing.
 - ✗ Risk of scratches or damage to the lid.
- Do not use the product when the lid is removed.

Cleaning of Blocked Part of E-bidet

The product can be removed, so that the bowl and the internal parts of the product can be cleaned.

1. Removal Method of E-bidet

1. Unplug the power plug from the plug seat.

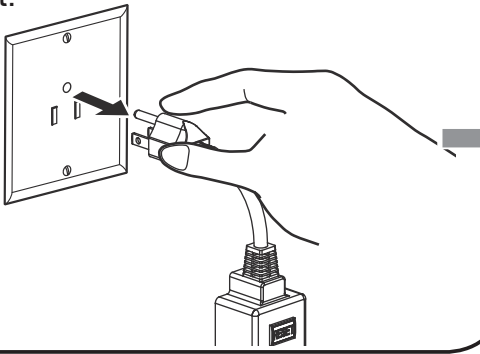

2. Turn off water supply valve and stop water supplying.

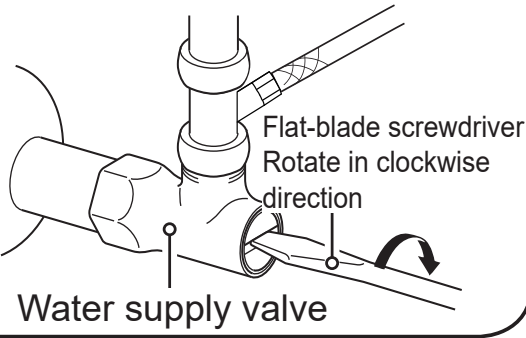

3. ① Push and hold the locking handle at the right hand side of the E-bidet.
② Slightly lift the product and slide out to remove it from the bowl.

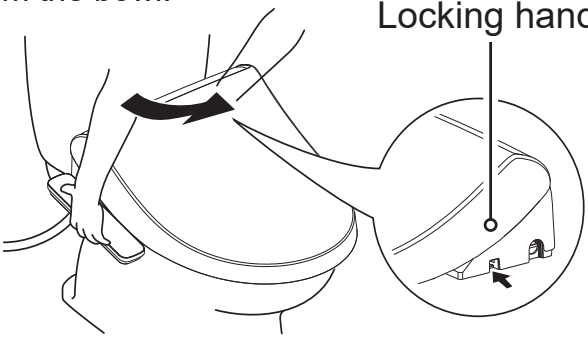

※ When removing, don't force to pull the seat and lid. please slowly pull the product. Pay attention not force to twist.

4. Gently put the product at the side of bowl.

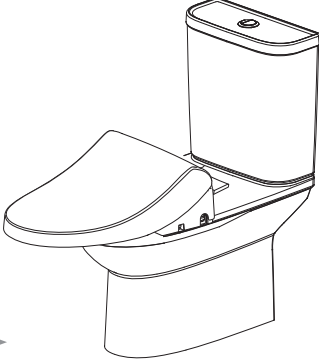

CLEANING AND CARE

Caution

1. Make sure unplug the power plug from the plug seat.
※ Risk of product malfunction.
2. Do not strain or pull the power cord or water supply hose of the E-bidet.
※ Risk of damage or water leakage.
3. When removing the E-bidet for cleaning, it must be treated gently.
※ Risk of water leakage or malfunction.

- Do not strain or pull

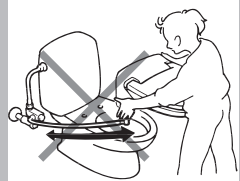

2. Cleaning Method

- When clean the E-bidet, please mop it by damp soft cloth.

Please clean here



※ When clean the bowl, Please refer to the manual of the bowl.

3. Installation Method of E-bidet

1. Place the E-bidet on the bowl align the middle of E-bidet and mounting plate.

Center of mounting plate

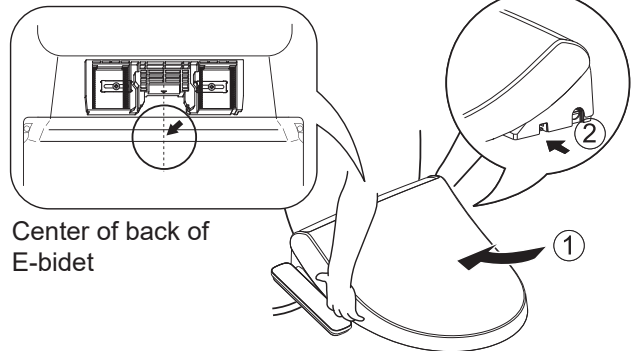

2. Raise up the front part slightly, slowly push the E-bidet to the end to hear a slight "click" sound.

※ After fixing, slightly rock the E-bidet back and forth, left and right, confirm if it was installed tightly.

3. Open the water supply valve to the original place.

※ Confirm the water leakage of each parts.

4. Connect the power plug to the plug seat.
Confirm the indicators of water temperature and seat temperature are same with that before unplugging the power source.

5. After installation, please do test run.

CAUTION

- Do not splash the E-bidet with detergent during cleaning. In addition, please properly clean the bowl with water before installing the E-bidet, so as to prevent detergent from remain on the bowl.
※ Remains of detergent may lead to malfunction.
- Do not insert finger or other stuff to the opened parts or around the nozzle.
※ Risk of personal injuries like injury to the finger or malfunction.
- Confirm that the E-bidet has been fixed properly.
※ E-bidet may detach from the bowl in case it is not fixed properly.
- Do not curve the pipes of the products.
※ The pipes may be distorted and cannot be restored to the original conditions, so water cannot be supplied.

Cleaning of Nozzle Shutter

- After applying the neutral detergent on a soft cloth or sponge, clean it with cold water or warm water.

[CAUTION]

- Do not clean it with a dry cloth or toilet paper.
- Do not clean it with a toothbrush.
- ※ Otherwise the scratches will occur.



Nozzle shutter can be removed for cleaning.

Removal of Nozzle Shutter

- 1 Open the lid and toilet seat.
- 2 Press **[Seat Temp]** + **[Water Temp]** , extend the nozzle.
 ※ Nozzle sticks out, nozzle shutter opens.
 Nozzle sprays water for 3 seconds.

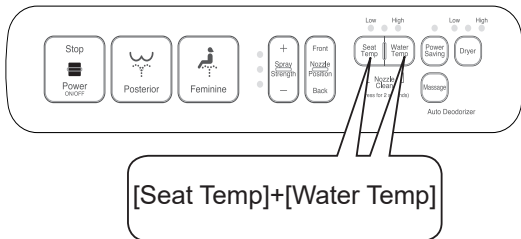

- 3 Pull the nozzle shutter up with your hands to remove it.

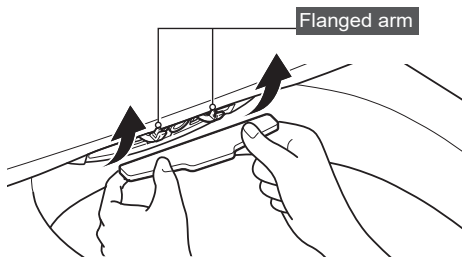

※ If difficult to remove, please push the flanged arm and remove the shutter.

- 4 Press the **[STOP]** key, nozzle will retract back.
- 5 Clean the removed nozzle shutter.

Installation of Nozzle Shutter

- 1 When nozzle does not stick out, press the clips (2 locations) of nozzle shutter into the groove on the bottom.
 ※ When nozzle sticks out, press STOP key to retract it back.

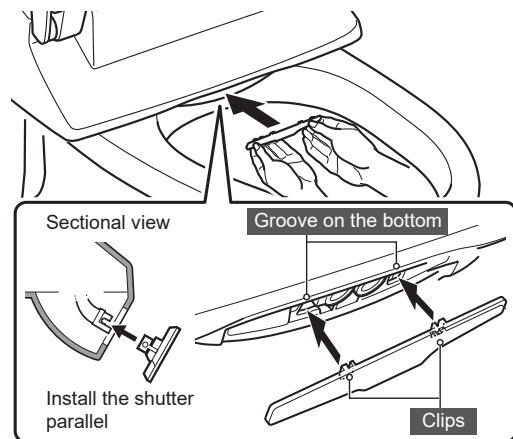

[CAUTION]

- Press inward until a "click" sound is heard.
- Pay attention to the orientation when installing , the sliding surface faces outward.
- Do not apply excessive force.
- ※ Otherwise it may lead to damage.

Cleaning Maintenance of Deodorization Filter

Cleaning Maintenance of Deodorization Filter

- 1** Unplug the power plug from the plug seat.
- 2** Remove the E-bidet from bowl.
- 3** Remove the filter from installation port of deodorization filter on left side of body undersurface.

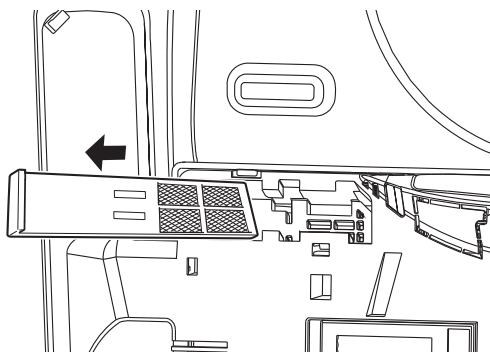

- 4** Remove the dirt from filter with a toothbrush etc.

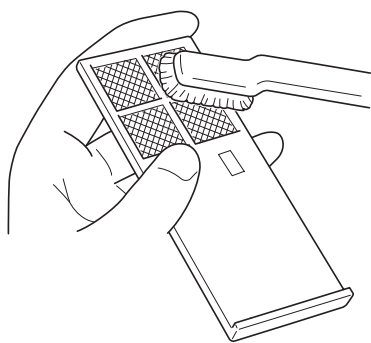

- 5** Install the filter on base plate of product.

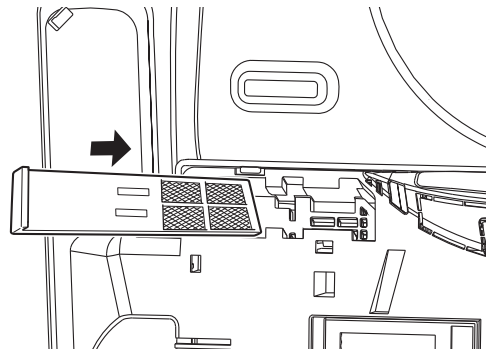

- 6** Install the E-bidet on bowl.
- 7** Insert the power plug into the plug seat.

■ When using it again
Be sure to do preparation and confirmation before using.

When Cleaning Function Decreases

When using the product for a long period, or feeling that spray strength of cleaning decreases, please clean the strainers of product in following order.
(About once for two years)

Cleaning Method of Strainer

1. Turn off water supply valve and stop water supplying.

※ As the water supply valve was adjusted, please remember original position (how many circles rotated).

2. Remove the strainer set by anti-clockwise rotating.

※ There will be some water outflowing, please put a container such as a pot under it.

3. Wash the dirt attached to strainer with water.

※ Do not loss the O-washer during washing.

4. Turn the strainer clockwise and tighten it.
Confirm that there are no dirt and foreign matter attached to O ring when installing. Otherwise will cause leakage or indoor ponding.

5. Open the water supply valve to the original place.

6. Be sure to do the test run at last.

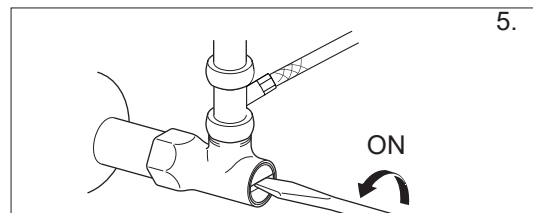
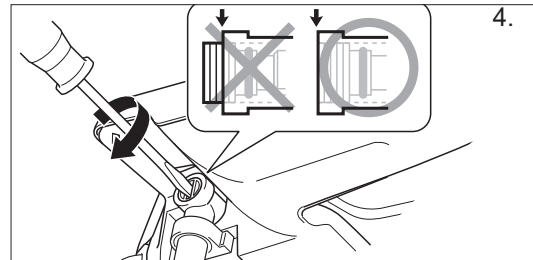
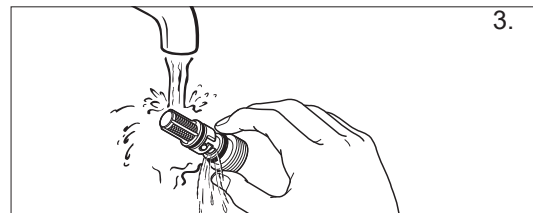
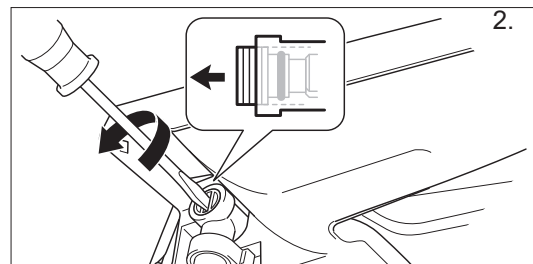
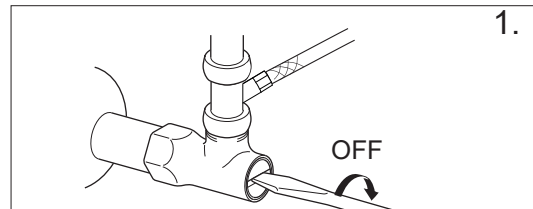

CAUTION

Please turn off water supply valve before removing the strainer.
When installing the strainer, please tighten it without leaving any gaps.
※ Or it may lead to water leakage.



When installing the strainer, please confirm that no dirt on O ring.
※ Or it may lead to water leakage and indoor ponding, thus result in possession loss.



HOW TO PREVENT FREEZING AND CARE DURING NOT USING FOR A LONG PERIOD

In cold winter, freezing of the water in water tank may cause E-bidet damage or water leakage. To avoid this issue, please make sure power plug is inserted into plug seat and turn on power supply, and cancel power saving function.

In the following circumstances, please drain the water from the product.

- Not use the E-bidet for a long time due to traveling etc.
- Not live in the house for a long time.

General anti-freezing measure

1. Set both WATER TEMP. and SEAT TEMP. to "HIGH" and close the lid.
2. Turn on the heater in the bathroom.

※ In case the heater is not available to the bathroom, please drain water in the E-bidet and water supply hose in accordance with the following methods.

Drain water and cut power supply

1. Unplug the power plug from plug seat.
2. Turn off water supply valve and stop water supply.

※ Please remember original position of water supply valve (how many circles rotated).

3. Release water in toilet water tank.
4. Drain water in E-bidet water supply hose.

- (1) Prepare container (such as washbasin) under water supply inlet.
- (2) Hold water supply inlet by hand and remove filter with a tool.
- (3) Wash the filter with clean water.
- (4) Remove the E-bidet from the toilet.
- (5) Incline the E-bidet to drain the water inside water supply hose.
- (6) After draining water, hold water supply inlet by hand and securely tighten filter with a tool.

5. Remove the drain water valve of warm water tank and drain water from warm water tank.

※ After draining water, tighten the drain water valve clockwise.

※ Install the E-bidet to toilet.

6. Plug the power plug to plug seat.
 7. Press the seat by hand, push Posterior button.
(drain the water inside valve of E-bidet)
 8. Press STOP button after about 5 seconds.
 9. Unplug power plug from plug seat.
- ※ When reusing the product, please do test run.

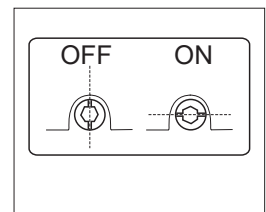
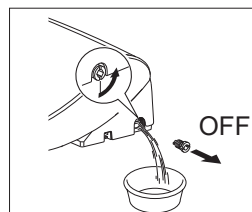
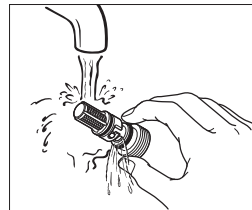
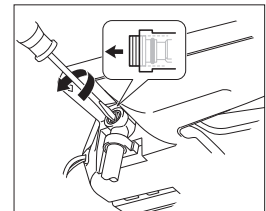
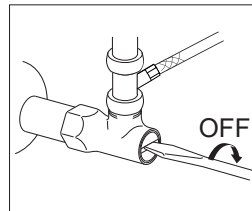

Caution

Please don't drain water when put the E-bidet under vertical.

※ Otherwise water easily flows inside causes malfunction.



GENERAL TROUBLE SHOOTING

Some problems can be solved easily, before applying for repair, check the items listed below.

If the problems cannot be solved with the help of following troubleshooting methods, please contact the store where you purchased the product, or contact customer service call center.

For some problems, you may still need to pay the repair charges even your warranty is still valid, please confirm the following items and records written in product quality assurance certificate.

All functions

Symptoms	Probable causes	Recommended action
All functions are not working	Plug seat is not energized.	Confirm if power is turned on or cut off.
	Power is turned off. (indicators of water temp. and seat temp. are not light on.)	Long time push power on/off button, indicators of water temp. and seat temp. will light on.
	Power plug is not inserted into plug seat.	Insert the power plug securely.
	<Application for leakage protector type> Electric leakage. (indicator of leakage protector is not light on)	Plug out power plug from plug seat, then plug in. Push the reset button on leakage protector, if still not work, please plug out and apply for repair.

SHOWER, BIDET

Symptoms	Probable causes	Recommended action
No action	Seat sensor not been activated.	Adjust sitting position, posture etc.
Water does not spray out of nozzles	Water supply valve is off.	Turn on the water supply valve.
	Mesh of filter is blocked.	Clean the filter.
	Water pressure is too low, and spray strength is set to "LOW".	Set spray strength to "HIGH".
	Seat sensor not been activated.	Adjust sitting position, posture etc.
	Warm water tank is not filled with water.	Test run.
Water temperature is not comfortable	Water temperature is not adjusted to a proper temperature.	Press WATER TEMP. button and adjust it to a proper temperature.
	Cleaning function has been used for quite a long time.	Need 3 minutes around to re-warm up.
	It is in power saving mode.	Release the power saving mode.

Warm air dryer

Symptoms	Probable causes	Recommended action
No action	Seat sensor not been activated.	Adjust sitting position, posture etc.
Wind is not warm	Warm air temperature is not set to a comfortable temperature.	Press the dryer button to adjust it to proper temperature.
Dryer function stopped during using	Use period is more than 4 minutes.	Press the dryer button again.

Seat heating

Symptoms	Probable causes	Recommended action
The seat is not warm	Seat temperature has not been set to a proper temperature.	Press SEAT TEMP. button, and adjust it to a proper temperature.
	It is in power saving mode.	Release the power saving mode.
Seat is cold after sitting on it for a long time	Auto shut off of seat heating is activated.	Inactivate auto shut off of seat heating.

Others

Symptoms	Probable causes	Recommended action
E-bidet position is not good	E-bidet is not locked.	Slide inwards to lock the E-bidet.

AFTER-SALES SERVICE

1. Before you submit the repair application

If a failure occurs to the product, please refer to <General Trouble shooting>.

If the failure could not be fixed, please contact the store where you purchased the product, or contact customer service call center.

If any of the following occurs, please contact customer service call center no matter a failure has occurred or not.

- The power cable is scratched, or the plug loosens.
- The plug seat, power plug or power cable overheats.

Warning

Please do not disassemble, repair or reform the product if you are not professional repairer.



※ Otherwise, it may lead to electric shock or fire, or wrong start of the product which will injure the user.

The above situations may lead to accidents if no measures are taken. Please do contact our technicians.

2. Please read through the Quality Assurance

Please read through the Quality Assurance and confirm if the product is in warranty term.

※ Please transfer the Quality Assurance to customer after filling specified items in store. Please confirm recorded contents and keep well.

※ Not necessarily guarantee for free repairing even the product is in warranty term, please read through the relevant contents recorded in Quality Assurance carefully.

The warranty term is 1 year after purchasing
(refer to the date written on invoice)

3. When you apply for repair

■Repair within warranty

Please present the Quality Assurance at repair. Repair according to specifications in Quality Assurance.

■Repair after warranty

Given the function of the product is maintained, repair can be done with payment according to client's requirement.

■Information needed

- 1 Address, name and telephone number
- 2 Model and product code (refer to product label)
- 3 Purchase date (refer to Quality Assurance)
- 4 Failure description and the anomaly (please be as detailed as possible)
- 5 The date you expect on-the-spot service

■Questions related to the product

If you have questions regarding the product and its usage, please call local call center or hotline.

ANTI-BACTERIAL

Anti-bacterial:

Toilet seat with antibacterial effect: KILAMIC antibacterial materials are used for toilet seat.
And toilet seat has passed the specific certification by SIAA.

KILAMIC antibacterial material has effect with inhibition of proliferation of bacteria on the surface of products.
Control quality management under ISO 22196 evaluation system and Society of international sustain growth for Antimicrobial Articles (SIAA) guidelines. It has confirmed that the antibacterial properties qualified through rigorous experiments.
Antibacterial activity value is over 2.0.

Explanation about KILAMIC materials:

1. Antibacterial effect: inhibition of proliferation of bacteria on the surface of products.
2. Antibacterial method: mix the anti-microbial agent into resinous material
3. Used antibacterial agent: silver-ion inorganic anti-microbial agent
4. Experimental method:
 - JISZ2801-2010 (ISO22196 Method)
5. Experimental organization:
 - Japan LIXIL Corporation R&D Division Analysis & Assessment Center Office
6. Experimental result:
 - Antibacterial activity value is over 2.0
 - Testing bacteria: colon bacillus and staphylococcus aureus
7. It is difficult to achieve the desired antimicrobial effect if there is dust or oil on the toilet seat surface.



For use-by date

Theoretical use-by date refers to theoretical service time without accident for the E-bidet with standard working condition, proper service and management.

■ Standard working condition

Environmental Conditions	Voltage · Frequency	AC220V · 50Hz
	Room Temperature	20°C
	Water Inlet Temperature & Pressure	15°C · 0.2MPa
	Installation Requirement	Private Bathroom, installed separately from the shower room
Load Conditions	Rated Load	Perform standard setting based on product specifications designed
Theoretical Time	Family of Four (2 male and 2 female), Using frequency: defecate: once/day for each person urinate: male: 4 times/day for each person; and female: 4 times/day for each person Can use E-bidet function for 15 seconds each time.	
Service & Maintenance	Following the procedures shown in the instruction, and perform service, inspection and repair.	



WARNING

【 Theoretical use-by date 】 10 YEARS

Please replace immediately when the product has passed theoretical use-by date. Or may cause fire or injury due to component deterioration.

- NOTICE:**
- ① Because the storage environment, the environment (such as the stability of electric power, environmental temperature and humidity, water, etc.), differences in methods of use, safe use of the actual product varies. The actual use of security products at public places may be significantly reduced.
 - ② Service time without accident does not mean free warranty.
 - ③ For the protection of the safe use of the product, please follow the instructions described in the method used, the daily cleaning and maintenance when necessary (such as unusual time), please contact our service hotline.
 - ④ For occasional accidents safe use period, the company will not compensate and not provide free repairs. Within the scope permitted by law, the Company reserves all the right of final interpretation for safe use.

SPECIFICATIONS

Model	CEAS7SL1-0100510P0 CEAS7SL1-0100510A0 CEAS7SL1-0100510V0 CEAS7SL1-0100510M0 CEAS7SS1-0100510H0	CEAS7SL2-0000510A0 CEAS7SL2-0000510M0 CEAS7SL2-0000510I0	CEAS7SL3-0000510P0 CEAS7SL3-0000510V0 CEAS7SL3-0000510M0 CEAS7SL3-0000511V0
Rated voltage	AC 220V 50Hz		
Rated power	300W		
Water pressure range	0.06MPa (flow pressure) — 0.75MPa (hydrostatic pressure)		
Ambient temperature range	0°C — 40°C		
Product size	CEAS7SLCollection: L536mm*W472mm*H173mm CEAS7SSCollection: L511mm*W472mm*H173mm		
Water inlet type	Direct inlet flow		
Wash	Warm water supply type	Warm water tank 0.7L	
	Posterior wash volume	0.25-0.6L/min (3/5 adjustment levels) water pressure 0.2MPa	
	Feminine wash volume	0.45-0.6L/min (3/5 adjustment levels) water pressure 0.2MPa	
	Warm water temperature	OFF (water temperature) Low (about 32°C) Mid-low (about 34°C) Mid (about 36°C) Mid-high (about 38°C) High (about 40°C) (6 adjustment levels)	
	One touch cleansing	•	
	Oscillating	•	
	Massage (posterior wash)	•	
	Nozzle position adjustment	•	
	Air bubble wash (feminine)	•	
	Power of warm water heater	250W	
	Safety device	Temp. sensor, Temp.fuse, High Temp.sensor switch	
Warm air dryer	Air volume	0.2 m ³ /min	—
	Warm air temperature	(room temperature·Low (about 30°C Mid (about 40°C) High (about 45°C) (4 adjustable levels)	
	Safety device	Temp.fuse, Temp. sensor	
Heated seat	Surface temperature	In use: room temperature: about 28°C — 40°C (6 adjustable levels) One touch power saving (8 hrs) setup: room temperature super power saving (ON OFF)	
	Power of heater	48W	
	Safety device	Temp.sensor, Temp. fuse	
Deodorizer	Deodorizing type	Chemisorption by activated carbon deodorizer	—
Power save	One touch power saving (8 hrs)	•	
	High efficiency power saving	•	
Others	Nozzle self-cleaning	•	
	Nozzle manual clean	•	
	Seat heating auto off	•	
	Electric leakage protector	•	
	Sitting sensor type	Mechanical sensor	
	Anti-bacterial	Seat, control panel, nozzle, seat cover	
	Soft close seat & cover	•	
Quick detach cover	•		
Quick detach	•		

Warranty Card

American Standard

Warranty Card

The product is warranted according to the description written on this warranty card. Please submit this warranty card to service center when there are malfunctions.

Model:		
Serial NO.:		
Purchaser		
Company:		
Address:		
City:		Country:
Phone:	Fax:	E-mail:
Dealer (Company)		
Address:		
Purchase Date :		Installation Date:

When a fault occurs in the case of normal use from purchase date (subject to the invoice), you can enjoy free maintenance service within one year.

Notice: the warranty does not cover the following:

1. When the impurities in the product to malfunction
2. When the product was thrown or hit and cause damage or malfunction
3. Use of an organic solvent such as thinner cause deformation or deterioration of appearance
4. When using non-genuine parts or consumable caused by fault
5. When using non-normal voltage caused by fault
6. When customers disassemble the product, resulting in lost or damaged parts
7. When repair or modify through non-designated service center technician caused malfunction
8. When a fault occurs due to natural disasters
9. When due to not following the instruction caused malfunction
10. Other conditions due to customers' intentional or negligent caused fault

Thailand

Hotline : 02 102-2222
Manufacture: American Standard B&K (Thailand)
Website : www.americanstandard.co.th

Vietnam

Hotline : 1800-6633
Manufacture: American Standard Vietnam
Website : www.americanstandard.com.vn

India

Hotline : 1-800-3010-8000
Manufacture: American Standard India
Website : www.americanstandard.in

Indonesia

Hotline : 0-800-1-267823
Manufacture: PT American Standard Indonesia
Website : www.americanstandard.co.id

Philippines

Hotline : 02-893-8681
Manufacture: American Standard Philippines
Website : www.americanstandard.com.ph

China

Hotline : 800-820-3191
Manufacture: American Standard (China) Limited Company
Website : www.americanstandard.com.cn